

PENETRATION OF CF-252  
NEUTRONS THROUGH LAMINATED SHIELDS

A Thesis

Submitted to the Graduate Faculty of the  
Louisiana State University and  
Agricultural and Mechanical College  
in partial fulfillment of the  
requirements for the degree of  
Master of Science

in

The Department of Nuclear Engineering

by  
James T. Robert  
B.S., Louisiana State University, 1972  
December, 1974

SN \* \*

142

ACKNOWLEDGEMENT

I would like to express my appreciation to the following individuals for their assistance in this study. First, I would like to thank my deeply indebted supervisor, Mr. Robert W. ... for his guidance and assistance in the selection of the topic, the formulation of the research objectives, the design of the study, the collection of data, and the preparation of the report. Mr. ... also provided me with the necessary facilities and equipment for the study. I would also like to thank Mr. ... for his assistance in the preparation of the report. Finally, I would like to express my appreciation to my wife and son for their help and support during the study.

Dedicated to my  
 wife and son

(NS) \*

## ACKNOWLEDGEMENT

I would like to express my heartfelt gratitude to a number of people for their assistance in this study. First, to Dr. John C. Courtney I am deeply indebted for his endless advice and encouragement. Dr. Frank Iddings and Dr. Robert McIlhenny provided invaluable technical consultations. Mr. Jim Morel helped immensely with computer applications of ANISN. Mr. Winton Aubert, Mr. John Rosso, and Mr. Dave Terrio provided important assistance in the construction of the experimental shields. Finally, I want to express a special thank-you to Mr. Charles Hartman for his many hours of work assisting with the experimentation.

REFLECTIONS

APPENDIX

APPENDIX

VITA

TABLE OF CONTENTS

|                                 | PAGE |
|---------------------------------|------|
| ACKNOWLEDGEMENT.....            | iii  |
| LIST OF TABLES.....             | v    |
| LIST OF FIGURES.....            | vi   |
| ABSTRACT.....                   | vii  |
| CHAPTER                         |      |
| I. Introduction.....            | 1    |
| II. The ANISN Model.....        | 3    |
| III. The SABINE Model.....      | 20   |
| IV. Experimental Procedure..... | 29   |
| V. Results and Conclusions..... | 33   |
| REFERENCES.....                 | 41   |
| APPENDIX A.....                 | 43   |
| APPENDIX B.....                 | 65   |
| VITA.....                       | 67   |

NS  
\*

LIST OF TABLES

| TABLE   | PAGE |
|---|------|
| 1. S-16 ANGULAR QUADRATURE COSINES AND WEIGHTS..... | 8    |
| 2. ANISN ZONE DESCRIPTIONS.....                     | 9    |
| 3. ANISN ENERGY GROUP STRUCTURE.....                | 12   |
| 4. SABINE GEOMETRY OPTIONS.....                     | 23   |
| 5. REMOVAL ENERGY GROUPS AND SOURCE FRACTIONS.....  | 25   |
| 6. SABINE DIFFUSION ENERGY GROUP STRUCTURE.....     | 26   |
| 7A. THERMAL FLUX.....                               | 34   |
| 7B. THERMAL FLUX RATIOS.....                        | 34   |
| 8A. RESONANCE FLUX.....                             | 35   |
| 8B. RESONANCE FLUX RATIOS.....                      | 35   |
| 9A. FAST FLUX.....                                  | 36   |
| 9B. FAST FLUX RATIOS.....                           | 36   |

LIST OF FIGURES

| FIGURE   | PAGE |
|--|------|
| 1. EXPERIMENTAL SOURCE-SHIELD GEOMETRY.....                                      | 5    |
| 2. Cf-252 SOURCE CAPSULE.....  | 6    |
| 3. ANISN SPHERICAL GEOMETRY FOR Fe-WEP-Fe SHIELD.....                            | 15   |
| 4. BOUNDARIES FOR SPHERICAL MODEL.....   | 16   |
| 5. ANISN SPHERICAL MODEL vs. EXPERIMENTAL GEOMETRY.....                          | 17   |
| 6. EXPERIMENTAL ARRANGEMENT FOR "INFINITE" HOMOGENEOUS MEDIUM<br>ACTIVATION..... | 19   |
| 7. SLAB SHIELDING CONFIGURATIONS.....  | 31   |

ABSTRACT

This study compares measurements with the results of discrete-ordinates and removal-diffusion calculations of neutron transport through both laminated and homogeneous shields. Multigroup neutron spectra from a fission neutron source were calculated using two digital computer codes, ANISN and SABINE. The discrete-ordinates code, ANISN, is widely used in the United States both for research and industrial applications. SABINE, a removal-diffusion code, originated in Europe where removal-diffusion theory is extensively utilized.

In this study calculated values of thermal ( $E_n < 0.414$  eV), resonance ( $E_n \approx 1.45$  eV), and fast ( $E_n > 3.0$  MeV) neutron fluxes penetrating through slab shields are compared to experimentally-determined values. Slab shielding materials used were Al, Fe, Pb, water-extended polyester, and borated-water-extended polyester. Californium-252 was used to provide a source of fission spectrum neutrons. An additional benchmark experiment in which thermal, resonance, and fast neutron spectra are determined in a homogeneous water medium was also performed.

The results of this thesis show, with respect to calculational accuracy, that the discrete-ordinates technique as applied in ANISN is far superior to the removal-diffusion method used by SABINE. This result is probably due to breakdown in age-diffusion theory for lamina having large differences in neutron slowing-down and diffusion properties. In the case of the benchmark experiment ANISN calculated a thermal flux value within 12% of the measured thermal flux. In comparison SABINE's

result was off by a factor of twenty. Also considering factors such as computer hardware and software, ANISN appears to be more desirable than SABINE. A typical laminated shielding problem required approximately half the central processing unit time to run on ANISN than it did on SABINE for the same computer core storage.

INTRODUCTION

transport through an object has increased. Quantitative methods  
various methods and techniques used in the past have been  
grown in number and complexity. The need for more sophisticated  
face, with a view to the future. The methods used in the past  
with the present methods. The methods used in the past were  
methods. The methods used in the past were simple and direct  
that were used in the past. The methods used in the past  
are: 1) direct methods, 2) indirect methods, 3) Monte Carlo  
In most situations, the methods used in the past were simple and direct  
better suited to the problem. The methods used in the past were  
complex methods of calculation. The methods used in the past  
time and money. The methods used in the past were simple and direct  
technique would be a valuable aid in the calculation of the  
between methods were used. The methods used in the past were  
valuable aid in the calculation of the radiation dose. The methods used in the past  
because of their inherent simplicity. The methods used in the past were  
radiation, this is a valuable aid in the calculation of the radiation dose.  
A computer program has been developed for the calculation of the  
calculating radiation dose. The methods used in the past were simple and direct





## CHAPTER I

### INTRODUCTION

With the advent and growth of the nuclear power industry, the need for expertise in solving the complex problem of radiation transport through shielding has increased. Consequently, the various methods and techniques used to solve this problem have grown in number and increased in complexity. Thus, an engineer faced with a shielding design problem is initially confronted with the decision to use one calculational method versus other methods. In making such a decision there are a number of factors that must be taken into consideration. Some of the major ones are: 1) cost, 2) time, and 3) the degree of accuracy required. In most solution methods, these three factors are closely related. Better answers usually entail more detailed calculations requiring complex methods of solution. This in turn costs more, both in time and money. The task of choosing a particular calculational technique would be much easier if consistent sets of comparisons between methods were readily available. Such comparisons are a valuable aid in the selection of the optimum method of analysis. Because of their interactions and production of secondary gamma radiation, this is especially true for neutrons.

A comprehensive analysis of all the various methods of calculating radiation transport would be an immense undertaking.

The study presented here compares two methods of calculation that are commonly used in radiation shielding. One is based on the discrete-ordinates method for solving the Boltzmann transport equation. The other method is a combination of "removal" theory with age-diffusion theory. Answers obtained using these two techniques are compared to experimentally measured values. The specific benchmark problem chosen was the determination of thermal, resonance, and fast neutron fluxes transported through several arrangements of laminated shields.

The solution to this problem involved five steps. First was the implementation of two computer codes and their accessory codes on the L.S.U. computer system. These two codes are: 1) ANISN, a multi-group one-dimensional discrete-ordinates transport code with anisotropic scattering; and 2) SABINE, a removal-diffusion shielding code in flexible geometry. The second step was to model the problem and use the codes to determine calculated flux values. Next, it was necessary to construct laminated shielding arrangements and accompanying equipment to make experimental measurements. The fourth step was to make the flux measurements using activation-foil techniques. Finally, the fifth step was to analyze the experimental data and compare it with the calculated results.

## CHAPTER II

### THE ANISN MODEL

A digital computer code, ANISN, is used in this study to treat the neutron transport problem. ANISN numerically solves the one-dimensional, energy-dependent Boltzmann transport equation for neutron or gamma penetration in slab, spherical, or cylindrical geometries. This code can handle three source arrangements: fixed sources, fission sources, and combinations of the two. Anisotropic scattering of radiation is treated by using Legendre polynomials. Also, multigroup cross-section sets may be weighted by using space and energy-dependent fluxes generated by the code.

The Boltzmann transport equation describes the general behavior of uncharged radiation quanta in terms of seven-dimensional phase space  $(\vec{r}, E, \vec{\Omega}, t)$ . Three spatial coordinates, the particle energy, two angles, and time constitute this phase space. For any physical situation, knowledge of the particle density overall phase space is a complete solution to the transport problem. A common form of the transport equation is:

$$\nabla \cdot \vec{\Phi}(\vec{r}, E, \vec{\Omega}, t) + \vec{\Phi}(\vec{r}, E, \vec{\Omega}, t) \Sigma = \vec{S}(\vec{r}, E, \vec{\Omega}, t) + \iint \vec{\Phi}(\vec{r}, E, \vec{\Omega}, t) \Sigma_s \cdot P(\vec{\Omega}, \vec{\Omega}', E, E') d\vec{\Omega}' dE' \quad (1-1)$$

where  $\nabla \cdot \vec{\Phi}(\vec{r}, E, \vec{\Omega}, t)$  describes the net flow of particles in the differential phase-space cell,

$\vec{\Phi}(\vec{r}, E, \vec{\Omega}, t) \Sigma$  describes the loss of particles from the cell by absorption and scattering out,

$\vec{S}(\vec{r}, E, \vec{\Omega}, t)$  describes the source of particles in the cell, and  $\iint \vec{\Phi}(\vec{r}, E, \vec{\Omega}, t) \Sigma_g \cdot P(\vec{\Omega}, \vec{\Omega}', E, E') d\vec{\Omega}' dE'$  describes the scattering of particles into the differential phase-space cell.

The discrete-ordinates,  $S_n$ , method is a procedure for obtaining a numerical solution of the energy-dependent linear Boltzmann transport equation. Fundamentally, the method is formulated as a finite-difference equation, and theoretically the solutions approach the exact solution of the Boltzmann equation as space, energy, and angular meshes approach differential size. ANISN is based on the discrete-ordinates technique introduced by Carlson. <sup>(1)</sup>

In order to compare ANISN-calculated values to empirically determined values, it is necessary to model the experimental problem according to options offered by the code. Modeling of a problem can be divided into three general areas: source-shield geometry modeling, materials and cross section modeling, and boundary condition modeling.

Since ANISN performs a one-dimensional calculation, three source-shield geometries are available. The first option treats a spherical source surrounded by shells of shielding material. In the second option, a line source surrounded by cylindrical shields is considered. The third option treats a planar source with slab shields. The experimental source-shield arrangement used in this study is shown in Figure 1.

Figure 2 is a diagram of the Cf-252 source encapsulation. Because of the small dimensions of the Cf-252 source, it was felt that the source geometry would be best represented by a point source approximation.

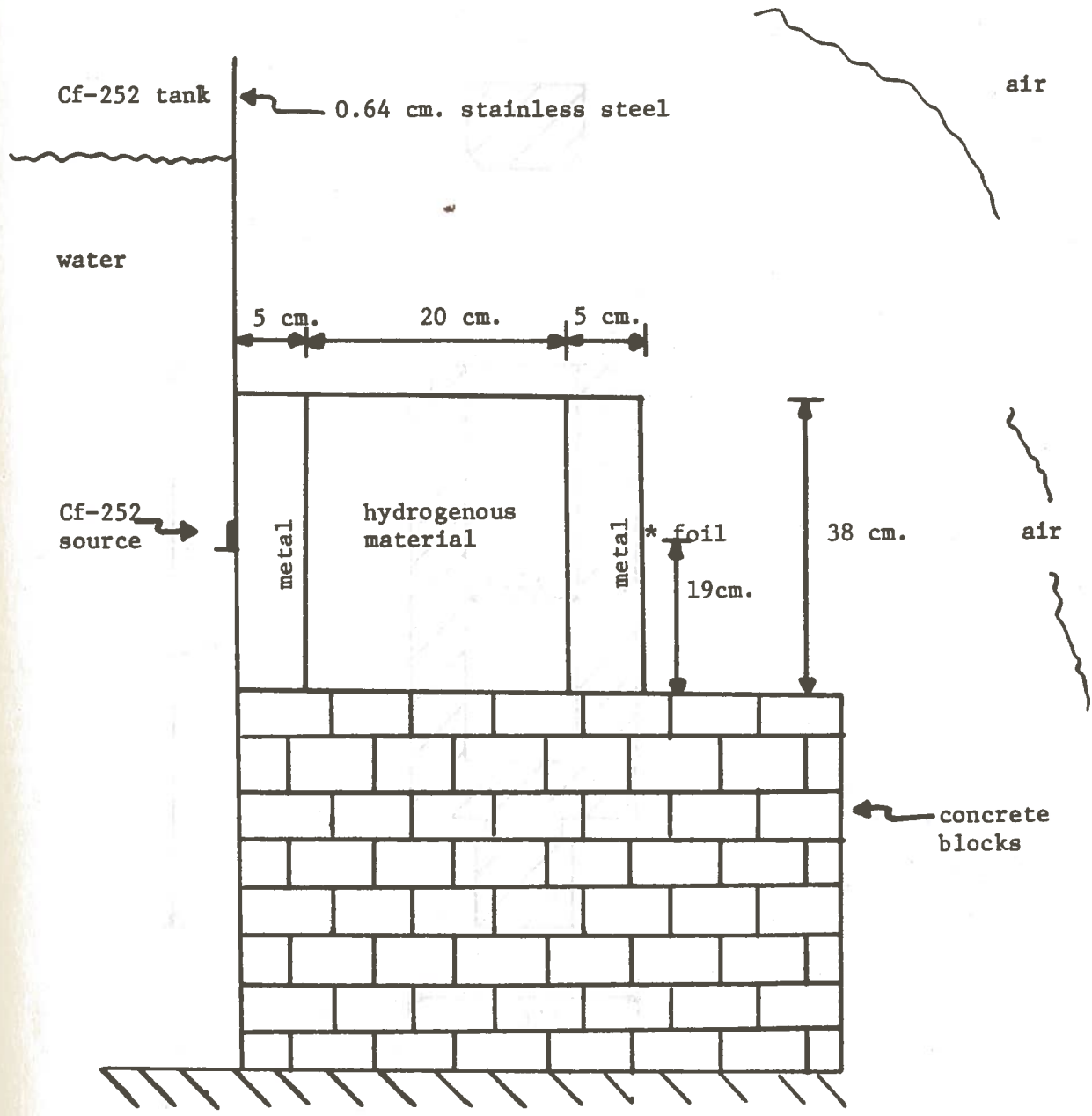

FIGURE 1. EXPERIMENTAL SOURCE-SHIELD GEOMETRY

FIGURE 2.

(SN) \*

... spherical ...

...

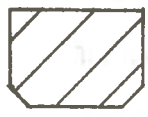

...

...

...

...

...

...

...

...

...

...

...

...

...

...

...

...

...

...

...

...

...

...

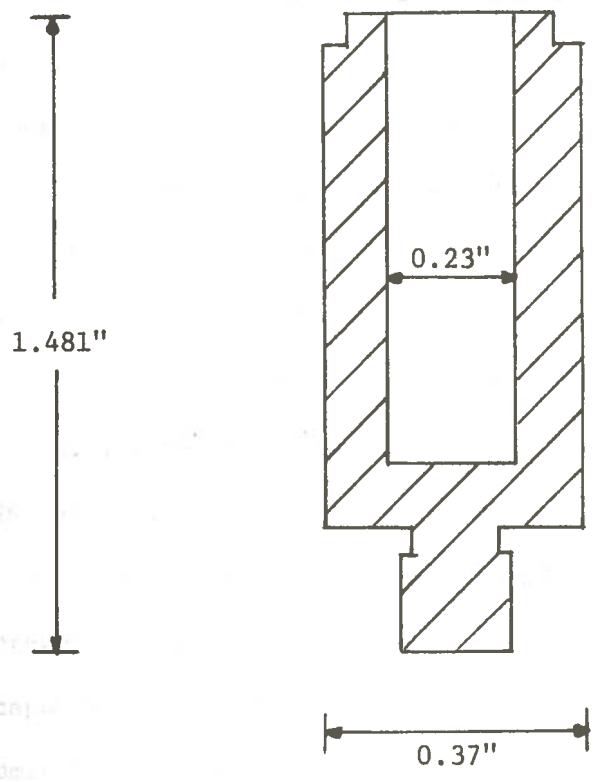

FIGURE 2. Cf-252 SOURCE CAPSULE

section 11...

(SN) \*

This approximation dictated using spherical geometry in the ANISN calculations.

Also of importance with respect to geometry is choosing an appropriate angular-quadrature set. The choice of quadrature was accomplished by performing several ANISN calculations going from a less detailed quadrature to a finer quadrature. It was found that an increase in angular quadrature above S-16 did not result in proportionately better answers. The cosines and weights for the S-16 quadrature are given in Table 1. (2)

In addition to quadrature, the size of the discrete meshes used can greatly affect results. Theoretically, as mesh spacing approaches differential sizes, better answers are obtained. (3) This author's previous experience gained working with the ANISN code influenced the choice of mesh spacing used for this study. The number of meshes, zone radii, zone thicknesses, and materials for each zone used in the ANISN calculations are presented in Table 2.

The next step in modeling the experimental problem for ANISN was to prepare cross-section sets for the various shielding materials. ANISN is capable of performing multigroup calculations; as group structure becomes finer, theoretical accuracy increases. An increase in the number of energy groups will result in a corresponding increase in the computer memory storage requirement and C.P.U. time. These two factors then limit the energy group structure which can be used in an ANISN calculation.

There is available on the L.S.U. computer system, a neutron cross-section library for 100 discrete energy groups, named DLC-2D.

TABLE 1

## S-16 ANGULAR QUADRATURE COSINES AND WEIGHTS

| <u>Cosine</u> | <u>Weight</u> |
|---------------|---------------|
| -0.990298     | 0             |
| -0.980501     | 0.0244936     |
| -0.909285     | 0.0413296     |
| -0.831997     | 0.0392569     |
| -0.746751     | 0.0400796     |
| -0.650426     | 0.0643754     |
| -0.537097     | 0.0442097     |
| -0.392289     | 0.109085      |
| -0.138957     | 0.13717       |
| 0.138957      | 0.13717       |
| 0.392289      | 0.109085      |
| 0.537097      | 0.0442097     |
| 0.746751      | 0.0643754     |
| 0.831997      | 0.0400796     |
| 0.909285      | 0.0392569     |
| 0.980501      | 0.0413296     |
| 0.990298      | 0.0244936     |

★  
(SN)  
★



TABLE 2 (cont.)

## ANISN ZONE DESCRIPTIONS

System 1: Fe - WEP\* - Fe

| <u>Zone No.</u> | <u>Zone Radii(cm.)</u> | <u>Material</u> | <u>Zone Thickness(cm.)</u> | <u>Mesh Spaces</u> |
|-----------------|------------------------|-----------------|----------------------------|--------------------|
| 1               | 0.5                    | Al              | 0.5                        | 1                  |
| 2               | 6.22                   | Fe              | 5.72                       | 5                  |
| 3               | 26.22                  | WEP             | 20.0                       | 20                 |
| 4               | 31.30                  | Fe              | 5.08                       | 5                  |

System 2: Fe - BWEP\*\* - Fe

| <u>Zone No.</u> | <u>Zone Radii(cm.)</u> | <u>Material</u> | <u>Zone Thickness(cm.)</u> | <u>Mesh Spaces</u> |
|-----------------|------------------------|-----------------|----------------------------|--------------------|
| 1               | 0.5                    | Al              | 0.5                        | 1                  |
| 2               | 6.22                   | Fe              | 5.72                       | 5                  |
| 3               | 26.22                  | BWEP            | 20.0                       | 20                 |
| 4               | 31.30                  | Fe              | 5.08                       | 5                  |

System 3: Al - WEP\* - Al

| <u>Zone No.</u> | <u>Zone Radii(cm.)</u> | <u>Material</u> | <u>Zone Thickness(cm.)</u> | <u>Mesh Spaces</u> |
|-----------------|------------------------|-----------------|----------------------------|--------------------|
| 1               | 0.5                    | Al              | 0.5                        | 1                  |
| 2               | 1.14                   | Fe              | 0.64                       | 1                  |
| 3               | 6.22                   | Al              | 5.08                       | 5                  |
| 4               | 26.22                  | WEP             | 20.0                       | 20                 |
| 5               | 31.30                  | Al              | 5.08                       | 5                  |

\* WEP - water-extended polyester(60% water in 40% resin)

\*\* BWEP - borated water-extended polyester(1.8 mg boron/cc of mixture)

TABLE 2 (cont.)

System 4: Al - BWEP\*\* - Al

| <u>Zone No.</u> | <u>Zone Radii(cm.)</u> | <u>Material</u> | <u>Zone Thickness(cm.)</u> | <u>Mesh Spaces</u> |
|-----------------|------------------------|-----------------|----------------------------|--------------------|
| 1               | 0.5                    | Al              | 0.5                        | 1                  |
| 2               | 1.14                   | Fe              | 0.64                       | 1                  |
| 3               | 6.22                   | Al              | 5.08                       | 5                  |
| 4               | 26.22                  | BWEP            | 20.0                       | 20                 |
| 5               | 31.30                  | Al              | 5.08                       | 5                  |

System 5: Pb - WEP\* - Pb

| <u>Zone No.</u> | <u>Zone Radii(cm.)</u> | <u>Material</u> | <u>Zone Thickness(cm.)</u> | <u>Mesh Spaces</u> |
|-----------------|------------------------|-----------------|----------------------------|--------------------|
| 1               | 0.5                    | Al              | 0.5                        | 1                  |
| 2               | 1.14                   | Fe              | 0.64                       | 1                  |
| 3               | 6.22                   | Pb              | 5.08                       | 5                  |
| 4               | 26.22                  | WEP             | 20.0                       | 20                 |
| 5               | 31.30                  | Pb              | 5.08                       | 5                  |

System 6: Pb - BWEP\*\* - Pb

| <u>Zone No.</u> | <u>Zone Radii(cm.)</u> | <u>Material</u> | <u>Zone Thickness(cm.)</u> | <u>Mesh Spaces</u> |
|-----------------|------------------------|-----------------|----------------------------|--------------------|
| 1               | 0.5                    | Al              | 0.5                        | 1                  |
| 2               | 1.14                   | Fe              | 0.64                       | 1                  |
| 3               | 6.22                   | Pb              | 5.08                       | 5                  |
| 4               | 26.22                  | BWEP            | 20.0                       | 20                 |
| 5               | 31.30                  | Pb              | 5.08                       | 5                  |

\* WEP - water-extended polyester(60% water in 40% resin)

\*\* BWEP - borated water-extended polyester(1.8 mg boron/cc of mixture)

TABLE 3

In order to use DLC-2D cross sections in ANISN-DOT format, it is necessary to collapse the 100-energy-group library to a smaller number of groups. This is accomplished by using a cross-section collapsing code named APRFX-I. <sup>(4)</sup> It is possible to use ANISN to collapse the 100-group cross sections; however, the computer core storage required for this operation is greater than that which is currently available on the L.S.U. system. Thus, APRFX-I must be used to produce the cross-section input for ANISN.

The group structure used in the ANISN calculations is listed in the first column of Table 3. Several other calculations were performed using 3 groups, 10 groups, and 13 groups of energy-averaged cross sections. The 25 group structure was chosen because it closely matches the 26-diffusion-group structure used in the removal-diffusion code, SABINE.

Another consideration with respect to cross sections is treatment of elastic scattering by use of Legendre polynomials. The DLC-2D library contains scattering cross sections expanded up to nine terms. This is called a P-8 approximation. As the order of the Legendre expansion increases, better results should be obtained. It was felt that a P-5 approximation would be sufficient for the calculations being performed. This decision was based on the trends used in other ANISN calculations. <sup>(5)</sup>

The final step in preparing the ANISN model is to determine the correct boundary conditions to be used. ANISN allows four options for

TABLE 3

## ANISN ENERGY GROUP STRUCTURE

| <u>Broad Group No.</u> | <u>Fine Groups*</u> | <u>E(eV)**</u>       | <u><math>\Delta E</math>(eV)</u> |
|------------------------|---------------------|----------------------|----------------------------------|
| 1                      | 1-9                 | $14.918 \times 10^6$ | $8.853 \times 10^6$              |
| 2                      | 10-14               | $6.065 \times 10^6$  | $2.385 \times 10^6$              |
| 3                      | 15-19               | $3.68 \times 10^6$   | $1.45 \times 10^6$               |
| 4                      | 20-24               | $2.23 \times 10^6$   | $8.80 \times 10^5$               |
| 5                      | 25-29               | $1.35 \times 10^6$   | $5.29 \times 10^5$               |
| 6                      | 30-34               | $8.21 \times 10^5$   | $3.23 \times 10^5$               |
| 7                      | 35-39               | $4.98 \times 10^5$   | $1.96 \times 10^5$               |
| 8                      | 40-44               | $3.02 \times 10^5$   | $1.19 \times 10^5$               |
| 9                      | 45-50               | $1.83 \times 10^5$   | $9.65 \times 10^4$               |
| 10                     | 51-54               | $8.65 \times 10^4$   | $5.47 \times 10^4$               |
| 11                     | 55-58               | $3.18 \times 10^4$   | $2.01 \times 10^4$               |
| 12                     | 59-62               | $1.17 \times 10^4$   | $7.39 \times 10^3$               |
| 13                     | 63-66               | $4.31 \times 10^3$   | $2.73 \times 10^3$               |
| 14                     | 67-70               | $1.58 \times 10^3$   | $9.97 \times 10^2$               |
| 15                     | 71-74               | $5.83 \times 10^2$   | $3.69 \times 10^2$               |
| 16                     | 75-78               | $2.14 \times 10^2$   | $1.35 \times 10^2$               |
| 17                     | 79-82               | 78.9                 | 49.9                             |
| 18                     | 83-86               | 29.0                 | 18.3                             |
| 19                     | 87-89               | 10.7                 | 5.66                             |
| 20                     | 90-91               | 5.04                 | 1.98                             |
| 21                     | 92-93               | 3.06                 | 1.21                             |
| 22                     | 94-95               | 1.85                 | 0.73                             |

TABLE 3 (cont.)

| <u>Broad Group No.</u> | <u>Fine Groups*</u> | <u>E(eV)**</u> | <u>E(eV)</u> |
|------------------------|---------------------|----------------|--------------|
| 23                     | 96-97               | 1.12           | 0.438        |
| 24                     | 98-99               | 0.682          | 0.268        |
| 25                     | 100                 | 0.414          | sink         |

\* Refers to groups in DLC-2D library

\*\* Upper bound of energy group

(SN) \*

the inner and outer boundary conditions. These are: vacuum (or no reflection), reflection, periodic, and white (albedo). A cross-sectional view of the ANISN spherical geometry of the Fe-WEP-Fe shielding arrangement is shown in Figure 3. In the spherical geometry case, ANISN makes use of hemispherical symmetry to perform its calculations. Thus boundary conditions must be specified at the inner or left boundary and at the outer or right boundary as illustrated in Figure 4.

It can be seen from Figure 1 that the experimental source-shield arrangement is a non-symmetrical, multi-region configuration. This complex geometry is impossible to model exactly in a one-dimensional analysis. The ANISN spherical-geometry model would be a sphere with an outer radius equivalent to the distance between the centerline of the Cf-252 source and the foil position (31.30 cm.). Figure 5 depicts such a sphere superimposed over the experimental geometry. From this figure it is seen that the outer boundary of the sphere would essentially be in three different mediums: water, air, and concrete. However, only one boundary condition can be specified for the entire outer boundary. Since the experimental measurements are made at a point on the boundary that is in the air medium, the vacuum boundary option was used to describe the outer boundary conditions.

The choice of an inner boundary condition is also complicated by the non-symmetrical physical arrangement. The best boundary

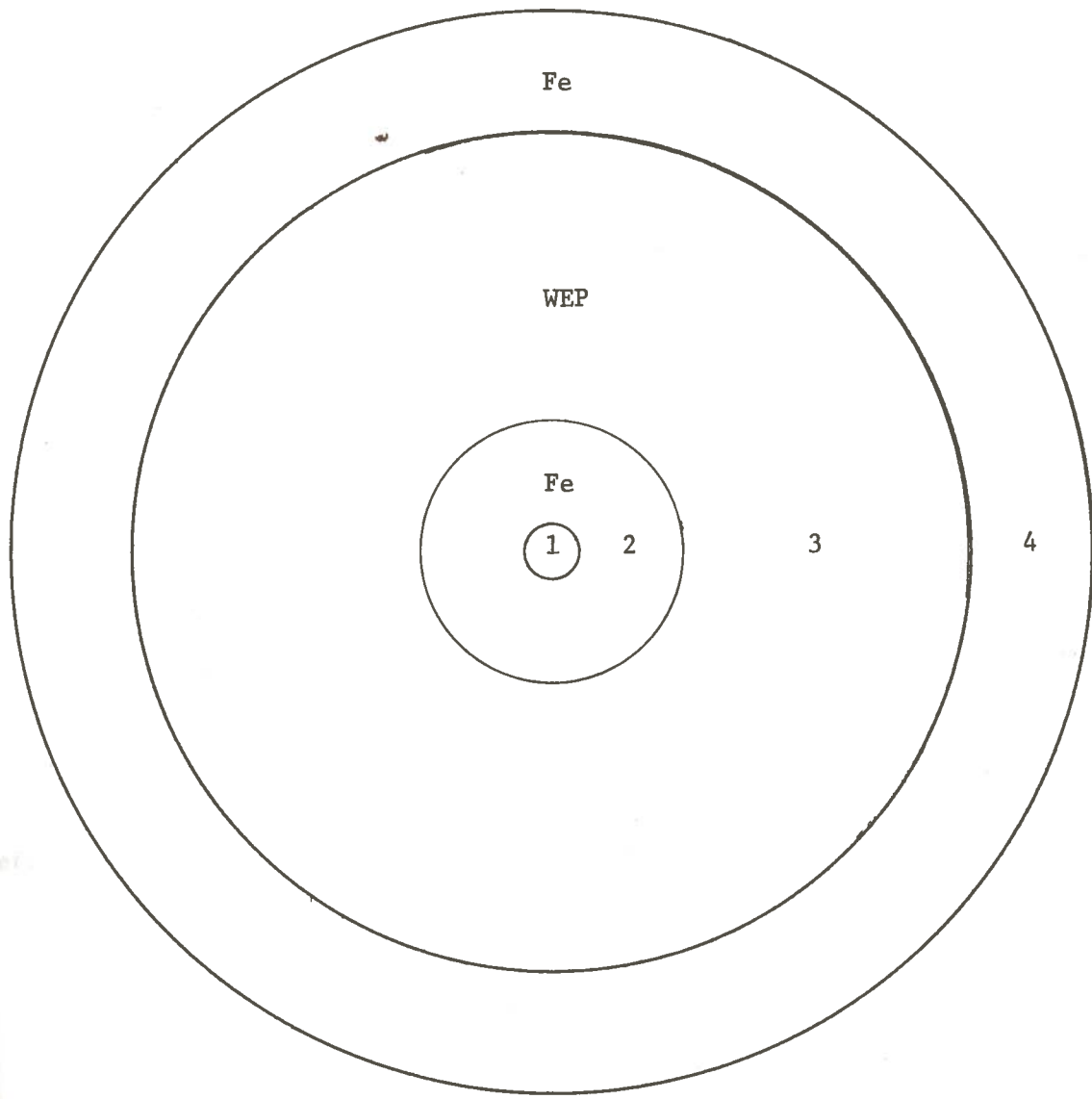

FIGURE 3. ANISN SPHERICAL GEOMETRY MODEL FOR Fe-WEP-Fe SHIELD

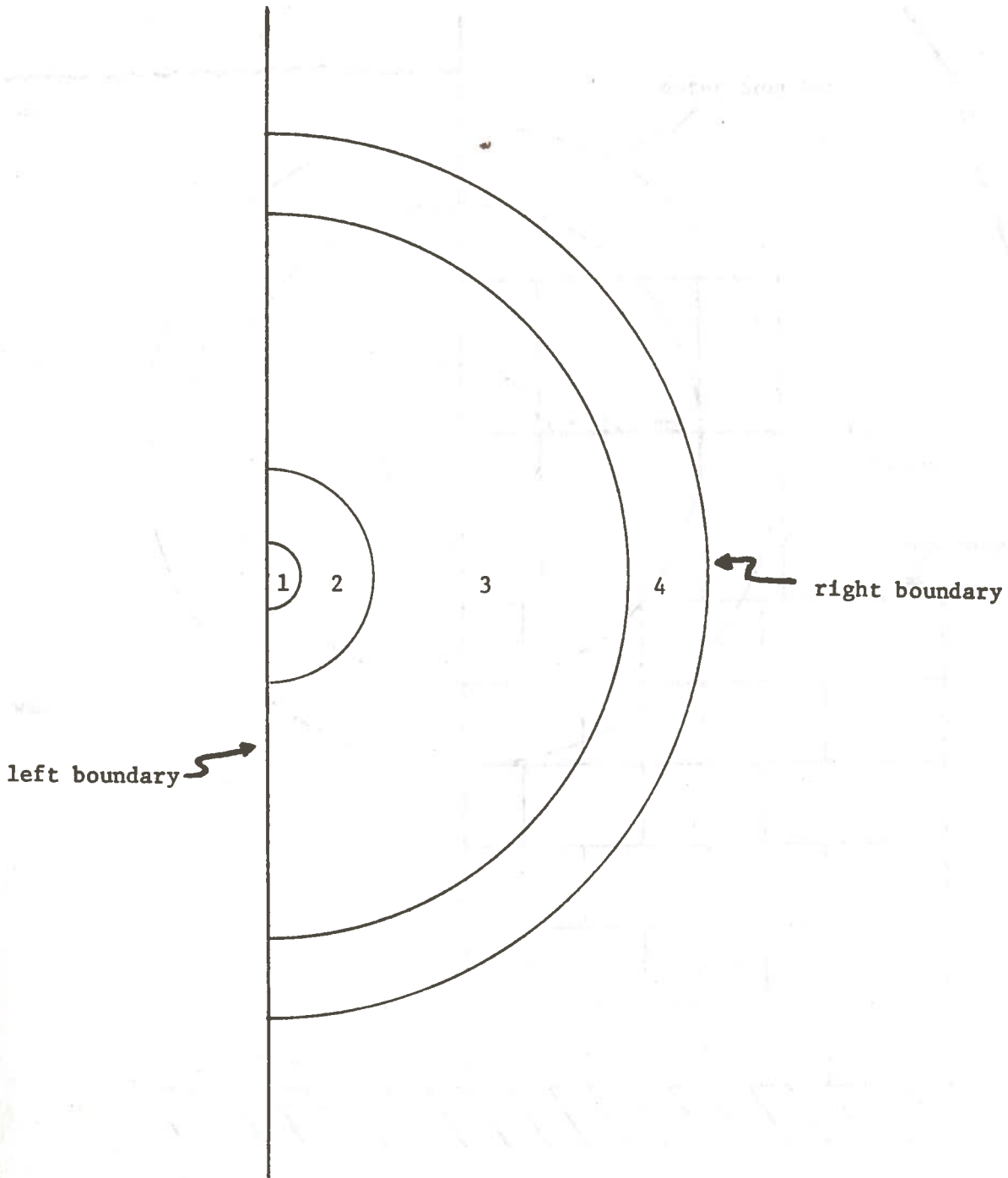

FIGURE 4. BOUNDARIES FOR SPHERICAL MODEL

(SN) ★



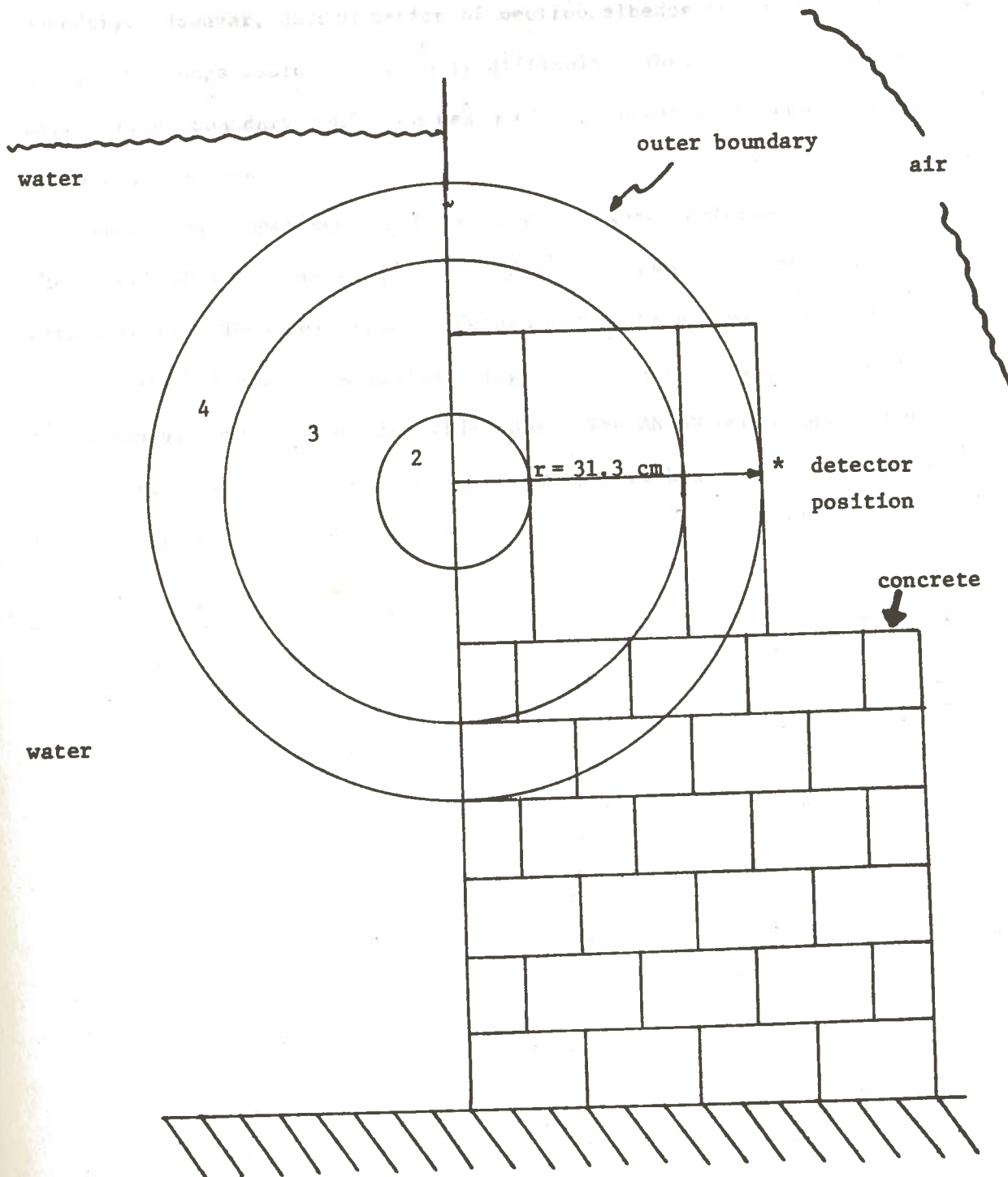

FIGURE 5. ANISN SPHERICAL MODEL vs. EXPERIMENTAL GEOMETRY

condition for the inner boundary probably would be a white (albedo) boundary. However, determination of neutron albedos for each of the 25 energy groups would be extremely difficult. Thus, a reflected, or mirror image boundary condition was used for the inner boundary in the ANISN calculations.

Additional experiments and calculations were performed to study the effect of the symmetrical modeling of non-symmetrical physical arrangements. These experiments determined neutron fluxes throughout an "infinite" homogeneous medium. Figure 6 is a representation of the experimental configuration for this case. The ANISN model was in spherical geometry, with two zones using the reflected boundary condition at both boundaries.

## CHAPTER III

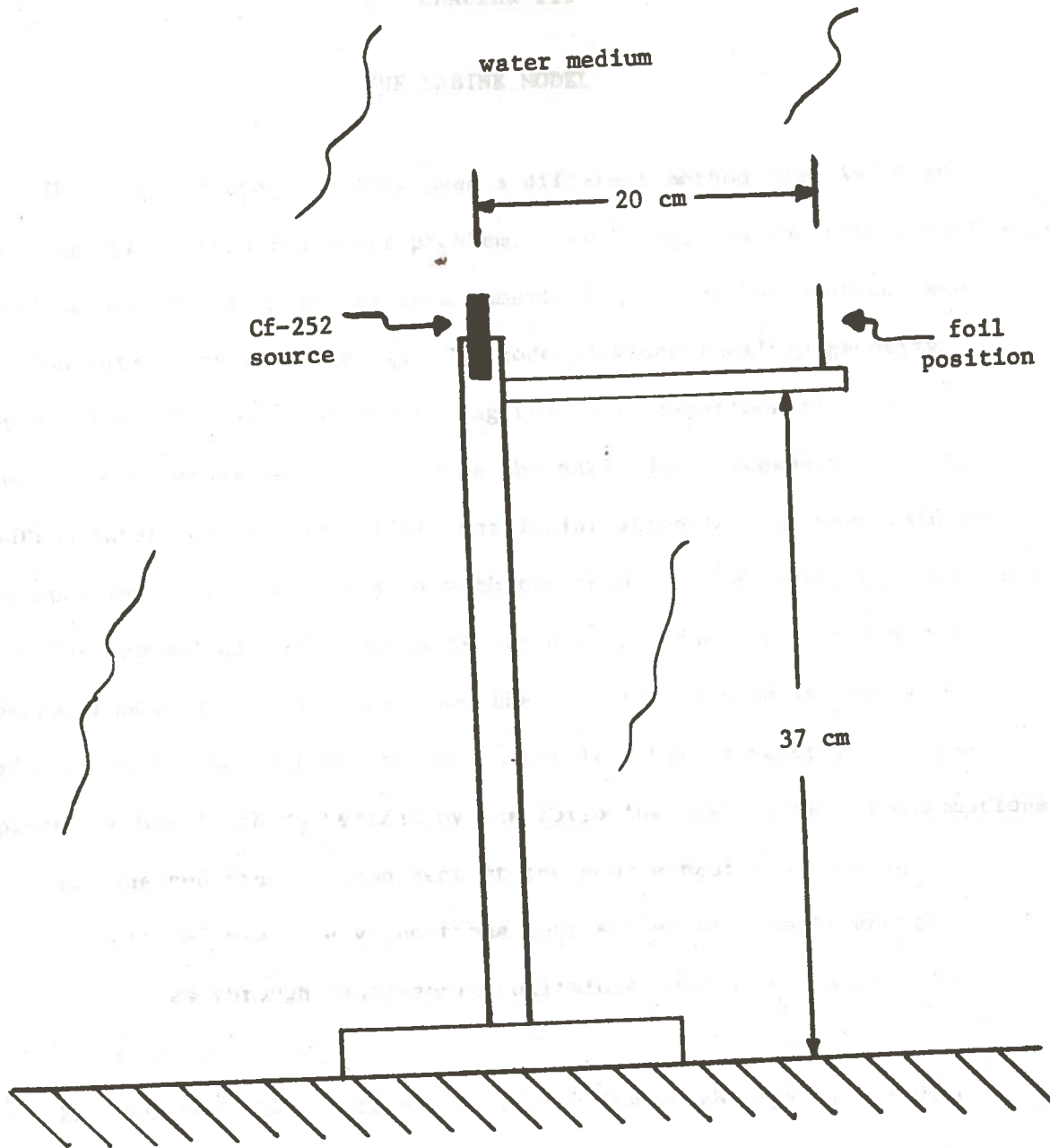

FIGURE 6. EXPERIMENTAL ARRANGEMENT FOR "INFINITE" HOMOGENEOUS MEDIUM ACTIVATION

## CHAPTER III

### THE SABINE MODEL

The computer code, SABINE, uses a different method than ANISN in treating the neutron transport problem. SABINE applies the removal-diffusion model in one dimension to obtain a numerical solution for neutron penetration through bulk shielding. The code provides flexible geometry options for both source and shielding regions. Experimentally determined removal cross sections provide the basic data necessary for fast neutron interactions. In SABINE, particular attention has been paid to the coupling of the removal flux with the input to the diffusion equations.

The removal-diffusion model is based on the fast neutron removal concept combined with age-diffusion theory. This method is commonly referred to as the "Spinney method" after its chief developer.<sup>(6)</sup> The Spinney method is characterized by the following basic physical assumptions:

1. The penetrating component of the source neutrons consists of: a) high-energy neutrons that suffer only small energy losses through small-angle collisions, and b) the uncollided neutrons.
2. Neutrons that suffer large energy losses through either wide-angle elastic or inelastic scattering are regarded as being removed from the beam of fast neutrons. This process is described by an energy-dependent "removal" cross section.
3. These "removed" neutrons are then rapidly degraded in energy

in accordance with Fermi age theory and do not travel very far from their point of removal. (7)

The penetrating component of the source neutrons is described by the kernel,

$$\phi_R(r, E) = S_o(E) \exp(-\Sigma_R(E)r) / 4\pi r^2 \quad (2-1)$$

where  $\phi_R(r, E)$  is the removal flux,

$S_o(E)$  = the source strength of fission spectrum neutrons,

$\Sigma_R(E)$  = removal cross section evaluated at energy E,

r = distance from the source.

Those neutrons which are removed can be considered as local sources of degraded neutrons. The behavior of these particles is described by age-diffusion theory. The source intensity is given by,

$$S(r) = \int (S_o(E) \Sigma_R(E) \exp(-\Sigma_R(E)r) / 4\pi r^2) dE \quad (2-2)$$

In one formulation, the removed neutrons are then introduced into the highest energy group of an appropriate set of one-dimensional multigroup diffusion equations. The equations comprising the multigroup set are:

$$\nabla^2 \phi_1(r) - \kappa_1^2 \phi_1(r) - \Sigma_1 / D_1 \phi_1(r) + S(r) / D_1 = 0, G=1 \quad (2-3)$$

$$\nabla^2 \phi_G(r) - \kappa_G^2 \phi_G(r) - \Sigma_G / D_G \phi_G(r) + D_{G-1} \kappa_{G-1}^2 \phi_{G-1}(r) = 0, G>1 \quad (2-4)$$

where  $\phi_G$  = group diffusion flux for Gth group,

$\Sigma_G$  = group-averaged macroscopic absorption cross section,

$D_G$  = group-averaged diffusion coefficient,

$1/\kappa_G$  = slowing down length for Gth group,

G = index of the energy group.

In SABINE, an improved version of the basic Spinney method is used.

Instead of one large removal group, a number of smaller, discrete removal

energy groups are used to characterize the fast neutron removal component. Also a complicated scheme of coupling the calculated group removal fluxes to the diffusion equations is used. This coupling is accomplished through the source terms in the diffusion equations. A detailed explanation of this method is given by Ponti. <sup>(8)</sup>

Preparing the SABINE model of the experimental problem involves a similar procedure to the ANISN modeling process. Generally, the three areas of interest are the source-shield modeling, materials and cross section modeling, and boundary conditions.

Table 4 lists the various geometry options available in SABINE. These geometry options apply both to the source and shield regions separately. Thus, in SABINE the source region can be modeled by one geometry configuration and the shield region by another. This factor provides increased flexibility in the geometry modeling process. It can be seen from Figure 2 that the Cf-252 source would be best described as a finite cylinder which can be treated by geometry option II. The shield geometry, illustrated in Figure 1, would be best described as finite plane slabs. SABINE does not have the ability to treat such a geometry. However, the actual Pd-Cf<sub>2</sub>O<sub>3</sub> cermet which is the source of neutrons approaches a point source with respect to the transverse dimensions of the shields. Thus, the shielding slabs could be considered as infinite plane slabs which can be treated with geometry option I. Consequently, the SABINE geometry model consisted of a finite cylindrical source and infinite plane slabs of shielding materials.

The next step in modeling the problem for SABINE is to prepare cross

The following TABLE 4 an appropriate cross section of

TABLE 4. This cross section of the geometry

#### SABINE GEOMETRY OPTIONS

- I. Infinite plane slabs.
- II. Finite or infinite cylinder radiating in the radial direction.
- III. Spherical.
- IV. Finite cylinder radiating along its axial direction. (Disk geometry)

NS  
\*

sections. The authors of SABINE provide an appropriate cross section library to be used with the code. This cross section library contains two types of data: removal cross sections and cross sections for the diffusion equations. Another code named SABLIB prepares the cross section data in the correct form for usage by SABINE. (8)

The energy-dependent removal cross sections used in SABINE come from several different sources. Experimentally determined values for  $H_2O$ , Pb, C, Fe, and Al are used. Removal data for other elements and isotopes has been compiled from several sources. (8) In addition to removal cross sections, the fraction of source neutrons emitted in each removal group is required for the calculations. Table 5 lists the removal energy group structure and the source neutron group fractions.

Cross section data for the diffusion calculations is taken from the General Atomic cross-section library. These cross sections are spectrum-weighted using calculated fast and thermal spectra in water. The fast spectrum calculation uses a P-3 approximation, and the thermal calculation uses a P-1 approximation. All the cross sections are group-averaged according to the diffusion energy group structure given in Table 6.

The next step in the SABINE modeling process is specification of boundary conditions. In SABINE it is necessary to specify boundary conditions at the outer boundary of the shield and at the source-shield interface. The code does not allow flux values to be given at the outer boundary because this is assumed to be a result and not a datum of the problem. The usual outer boundary condition is of zero incoming current.

MS  
★



TABLE 5  
REMOVAL ENERGY GROUPS and SOURCE FRACTIONS

| <u>Group No.</u> | <u><math>E_H</math> (MeV)</u> | <u><math>\Delta E</math> (MeV)</u> | <u><math>F_i</math></u> |
|------------------|-------------------------------|------------------------------------|-------------------------|
| 1                | 18.0                          | 1.5                                | $5.085 \times 10^{-5}$  |
| 2                | 16.5                          | 1.582                              | $7.91 \times 10^{-5}$   |
| 3                | 14.918                        | 0.918                              | $1.1 \times 10^{-4}$    |
| 4                | 14.0                          | 1.0                                | $2.3 \times 10^{-4}$    |
| 5                | 13.0                          | 1.0                                | $4.6 \times 10^{-4}$    |
| 6                | 12.0                          | 1.0                                | $9.08 \times 10^{-4}$   |
| 7                | 11.0                          | 1.0                                | 0.002                   |
| 8                | 10.0                          | 1.0                                | 0.003                   |
| 9                | 9.0                           | 1.0                                | 0.006                   |
| 10               | 8.0                           | 1.0                                | 0.012                   |
| 11               | 7.0                           | 0.935                              | 0.02057                 |
| 12               | 6.065                         | 0.865                              | 0.03287                 |
| 13               | 5.2                           | 0.8                                | 0.048                   |
| 14               | 4.4                           | 0.72                               | 0.06552                 |
| 15               | 3.68                          | 0.68                               | 0.0884                  |
| 16               | 3.0                           | 0.77                               | 0.14                    |
| 17               | 2.23                          | 0.88                               | 0.22                    |
| 18               | 1.35                          | 0.529                              | 0.157                   |
| 19               | 0.821                         | --                                 | 0.203                   |

$E_H$  = upper energy of the group

$\Delta E$  = group width

$F_i$  = fraction of fission neutrons emitted into  $i^{\text{th}}$  group

TABLE 6 (cont.)

## SABINE DIFFUSION ENERGY GROUP STRUCTURE

| <u>Group No.</u> | <u>E<sub>H</sub></u> | <u>ΔE</u> |
|------------------|----------------------|-----------|
| 0                | 18.0 MeV             | 3.082 MeV |
| 1                | 14.918               | 8.853     |
| 2                | 6.065                | 2.385     |
| 3                | 3.68                 | 1.45      |
| 4                | 2.23                 | 880.0 KeV |
| 5                | 1.35                 | 529.0     |
| 6                | 821.0 KeV            | 323.0     |
| 7                | 498.0                | 196.0     |
| 8                | 302.0                | 119.0     |
| 9                | 183.0                | 96.5      |
| 10               | 86.5                 | 54.7      |
| 11               | 31.8                 | 20.1      |
| 12               | 11.7                 | 7.39      |
| 13               | 4.31                 | 2.73      |
| 14               | 1.58                 | 997.0 eV  |
| 15               | 583.0 eV             | 369.0     |
| 16               | 214.0                | 135.1     |
| 17               | 78.9                 | 49.9      |
| 18               | 29.0                 | 18.3      |
| 19               | 10.7                 | 5.66      |
| 20               | 5.04                 | 1.98      |
| 21               | 3.06                 | 1.21      |

TABLE 6 (cont.)

| <u>Group No.</u> | <u><math>E_H</math></u> | <u><math>\Delta E</math></u> |
|------------------|-------------------------|------------------------------|
| 22               | 1.85                    | 0.73                         |
| 23               | 1.12                    | 0.438                        |
| 24               | 0.682                   | 0.268                        |
| 25               | 0.414                   | 0.214                        |
| 26               | 0.200                   | sink                         |

$E_H$  = upper energy of group

$\Delta E$  = width of group



That is:

$$J_- = \phi/4 + D\phi'/2 = 0 \quad (2-5)$$

where  $J_-$  is the incoming current,

$\phi$  is the boundary flux,

$D$  is the diffusion coefficient.

At the inner boundary, some form of boundary condition with respect to the diffusion flux must be given. Three options are available in the code:

1.  $\phi_G(r_1) = \phi_{0G}$

where  $\phi_G(r_1)$  = the group diffusion flux at the inner boundary  $r_1$ ,

$\phi_{0G}$  = total flux (removal flux plus diffusion flux) for  $G \leq 6$ ,

$\phi_{0G}$  = diffusion flux for  $G > 6$ ,

$G$  = index of diffusion energy groups.

2.  $\phi'_G(r_1) = 0$

3.  $-D\phi'_G(r_1) = J_{0G}$

In a previous comparison of ANISN and SABINE calculations by J.T. West,<sup>(9)</sup> the first boundary condition option was used. The boundary fluxes were taken from the ANISN calculation of the same problem. This type of procedure is also suggested by the authors of SABINE. Thus a similar procedure is used in this study. The group fluxes at the source-shield interface previously calculated by ANISN are used as the inner boundary fluxes ( $\phi_0$ 's) in the SABINE calculations.

## CHAPTER IV

### EXPERIMENTAL PROCEDURE

An important part of this study was the experimental determination of the thermal ( $E_n < 0.414\text{eV}$ ), resonance ( $E_n \approx 1.45\text{eV}$ ), and fast ( $E_n > 3.0\text{MeV}$ ) neutron fluxes penetrating a series of laminated slab shields. Three steps were required to accomplish this task. First, the shields had to be designed and constructed. Second, thermal and resonance fluxes were measured using capture reactions in indium foils. Third, the fast flux was measured utilizing the  $^{32}\text{S}(n,p)^{32}\text{P}$  threshold reaction. In addition, measurements of the thermal, resonance, and fast neutron fluxes were made in an "infinite" homogeneous water medium. The dimensions in the water were large in comparison to neutron slowing down and diffusion parameters. This additional experimental procedure was performed to study the effects of the symmetrical mathematical modeling of non-symmetrical shielding systems.

Before any measurements could be made, it was necessary to design and construct some shielding arrangements. In the design phase several factors such as cost, availability of materials, and ease of construction were taken into consideration. A major goal of the experimental procedure was to make flux measurements with many different shielding configurations. With these factors in mind, it was felt that laminated slab shields offered the greatest experimental flexibility at the lowest cost. The shields did not have to be massive since their function was not really shielding, but rather only attenuation of a localized beam of neutrons.

The basic shielding materials were chosen to reflect realistic considerations in shield design. That is, metal was used for primary and secondary gamma shields, and hydrogenous material was used for the neutron shield. Figure 7 is a schematic of the shielding configurations. Aluminum, iron, and lead were used as the metal shields because of their cost, availability, and range of densities. Two aluminum slabs, 24 in. x 24 in. x 2 in., and four steel slabs, 15 in. x 15 in. x 1 in., were used. Lead bricks, 6 in. x 4 in. x 2 in., were stacked to construct the lead shields. The hydrogenous shields were fabricated of water-extended polyester (40% polyester resin and 60% water) and borated-water-extended polyester (10 mg of boric acid/cc of mixture). Each of the hydrogenous arrangements consisted of four, 15 in. x 15 in. x 5 cm., slabs. Six different shielding combinations were used: Fe-WEP-Fe, Fe-BWEP-Fe, Al-WEP-Al, Al-BWEP-Al, Pb-WEP-Pb, Pb-BWEP-Pb. The cost of all the basic materials and shield fabrications was about \$100.

Measurements of the thermal neutron flux and the 1.45 eV resonance flux were made by activation of indium foils. Standard foil-activation techniques were utilized. <sup>(10)</sup> Activation times and foil weights were chosen such that the fifty-four minute In-116m gamma activity produced would yield high counting rates. These rates were sufficient to obtain counts, in a reasonable amount of time, having one standard deviation within  $\pm 2\%$  of the count. Corrections were made for thermal flux depression, self-shielding by the indium foils, and the perturbations due to the cadmium covers. <sup>(10)</sup>

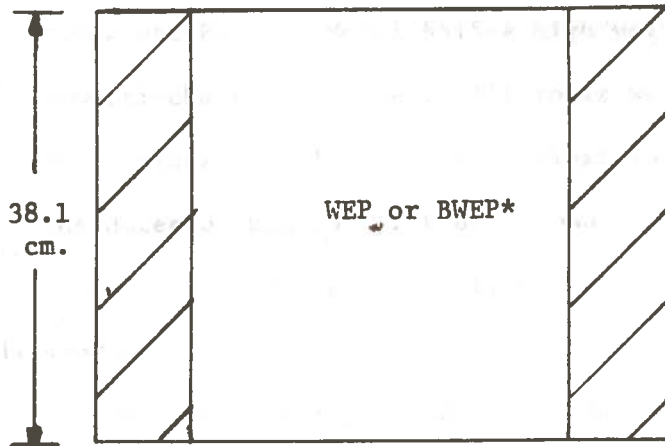

Pb or Fe

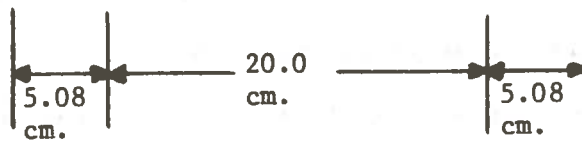

\* See text for identification

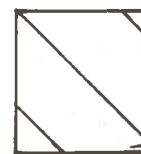
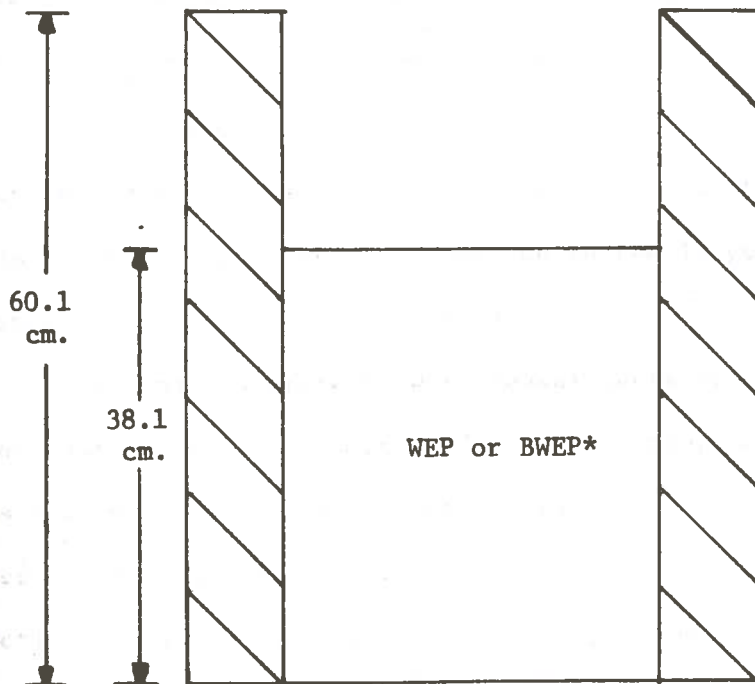

Al

FIGURE 7. SLAB SHIELDING CONFIGURATIONS

The detection system used to count the activated indium foils consisted of a 3 in. x 3 in. NaI(Tl) scintillation crystal (Harshaw type 12-S-12), a Hewlett-Packard Model 6515-A high voltage supply, and a TMC Model 401-D multi-channel analyzer. All foils were counted bare, positioned on the surface of a 1.5 cm. thick plexiglass shield atop the NaI(Tl) crystal. The detector was calibrated to count the indium 1.293 MeV gamma by using the Co-60 1.33 MeV gamma emitted from a National Bureau of Standards source.

The fast neutron flux ( $E_n > 3.0$  MeV) was determined by use of the  $^{32}\text{S}(n,p)^{32}\text{P}$  threshold reaction. This measurement was performed by using an ethyl disulfide activation procedure as described by Morel.<sup>(11)</sup> Five milliliter samples of ethyl disulfide were activated for approximately twelve hours and then allowed to decay for at least twenty-four hours. The P-32 activity in the samples was then counted using a Beckman LS-250 liquid scintillation counter. Counting efficiency for a 5 ml. sample was determined from data compiled by Greene<sup>(12)</sup> for the same liquid scintillation system. Flux perturbations due to the large sample size were minimal and thus were disregarded.

The final experiments were measurements of the thermal, resonance, and fast neutron fluxes in an "infinite" homogenous water medium. Figure 6 is a diagram of the experimental apparatus. Indium foil activations were used to measure the thermal and resonance fluxes, and ethyl disulfide activation was used to determine the fast flux. The measurements were made in the californium shielding facility, several feet away from the other Cf-252 sources. Twenty centimeters was used as the source to detector distance, which is equivalent to the thickness of the hydrogenous slab shields used in the previous experiments.



CHAPTER V

RESULTS AND CONCLUSIONS

The results of the experimental measurements and the calculations are presented in Tables 7A, 8A, and 9A. Tables 7B, 8B, and 9B present the calculated-to-measured flux ratios for the thermal, resonance, and fast neutron fluxes. A review of these data indicate that the ANISN calculations compared more favorably with measured values than did the SABINE calculations. Consideration of the thermal, resonance, and fast neutron results separately for the laminated shield configurations and the "infinite" water medium will be useful in a more thorough analysis of the data.

All of the ANISN-calculated thermal neutron fluxes for the laminated shields fell within a factor of two of the measured values. In contrast, the SABINE results were at least a factor of 84 times greater than the experimental results. For the "infinite" water medium, the ANISN calculation was within  $\pm 13\%$  of the measurement, while SABINE calculated a value 21 times greater. The inaccurate ANISN-modeling of the non-symmetrical physical geometry is a possible explanation for the differences observed in the ANISN results for the laminated shielding cases. In the experimental configuration, the water in the tank containing the neutron source acted as a neutron reflector, boosting the thermal flux at the point of measurement. Since the ANISN boundary conditions did not account for this reflection, the calculated values were less than the measured thermal fluxes. The results of the "infinite" water medium experiment

TABLE 7A  
THERMAL FLUX\*

| <u>Shield</u> | <u>Measured**</u>    | <u>ANISN</u>         | <u>SABINE</u>        |
|---------------|----------------------|----------------------|----------------------|
| Fe-WEP-Fe     | $4.0 \times 10^{-7}$ | $7.0 \times 10^{-8}$ | $6.9 \times 10^{-5}$ |
| Fe-BWEP-Fe    | $1.1 \times 10^{-7}$ | $2.1 \times 10^{-8}$ | $1.7 \times 10^{-5}$ |
| Al-WEP-Al     | $1.5 \times 10^{-5}$ | $1.7 \times 10^{-6}$ | $2.0 \times 10^{-3}$ |
| Al-BWEP-Al    | $3.9 \times 10^{-6}$ | $3.9 \times 10^{-7}$ | $4.5 \times 10^{-4}$ |
| Pb-WEP-Pb     | $1.6 \times 10^{-5}$ | $1.9 \times 10^{-6}$ | $1.8 \times 10^{-3}$ |
| Pb-BWEP-Pb    | $4.3 \times 10^{-6}$ | $4.4 \times 10^{-7}$ | $3.6 \times 10^{-4}$ |
| Water         | $2.2 \times 10^{-4}$ | $2.4 \times 10^{-4}$ | $4.5 \times 10^{-3}$ |

\* All values are given in units of  $n\text{-cm}^{-2}\text{sec}^{-1}$  per source neutron as determined by indium foil activation.

\*\* Experimental error is estimated to be within  $\pm 15\%$  due to combined errors in the activation cross section, counting, and flux perturbations.

TABLE 7B  
THERMAL FLUX RATIOS

| <u>Shield</u> | <u>ANISN/Measured</u> | <u>SABINE/Measured</u> |
|---------------|-----------------------|------------------------|
| Fe-WEP-Fe     | 0.18                  | 173                    |
| Fe-BWEP-Fe    | 0.19                  | 159                    |
| Al-WEP-Al     | 0.11                  | 138                    |
| Al-BWEP-Al    | 0.10                  | 114                    |
| Pb-WEP-Pb     | 0.12                  | 112                    |
| Pb-BWEP-Pb    | 0.10                  | 84                     |
| Water         | 1.12                  | 21                     |

TABLE 8A  
RESONANCE FLUX\*

| <u>Shield</u> | <u>Measured**</u>    | <u>ANISN</u>         | <u>SABINE</u>         |
|---------------|----------------------|----------------------|-----------------------|
| Fe-WEP-Fe     | $4.3 \times 10^{-8}$ | $8.8 \times 10^{-9}$ | $1.7 \times 10^{-5}$  |
| Fe-BWEP-Fe    | $5.5 \times 10^{-8}$ | $8.4 \times 10^{-9}$ | $1.9 \times 10^{-5}$  |
| Al-WEP-Al     | $5.9 \times 10^{-8}$ | $4.2 \times 10^{-8}$ | $1.02 \times 10^{-4}$ |
| Al-BWEP-Al    | $6.1 \times 10^{-8}$ | $3.9 \times 10^{-8}$ | $1.0 \times 10^{-6}$  |
| Pb-WEP-Pb     | $3.6 \times 10^{-8}$ | $3.4 \times 10^{-8}$ | $6.0 \times 10^{-5}$  |
| Pb-BWEP-Pb    | $3.5 \times 10^{-8}$ | $3.2 \times 10^{-8}$ | $6.1 \times 10^{-5}$  |
| Water         | $1.8 \times 10^{-8}$ | $5.4 \times 10^{-6}$ | $2.2 \times 10^{-4}$  |

\* All values are given in units of  $n\text{-cm}^{-2}\text{sec}^{-1}$  per source neutron as determined by indium foil activation.

\*\* Experimental error is estimated to be within  $\pm 50\%$  due to error in the resonance activation cross section.

TABLE 8B  
RESONANCE FLUX RATIOS

| <u>Shield</u> | <u>ANISN/Measured</u> | <u>SABINE/Measured</u> |
|---------------|-----------------------|------------------------|
| Fe-WEP-Fe     | 0.21                  | 398                    |
| Fe-BWEP-Fe    | 0.15                  | 336                    |
| Al-WEP-Al     | 0.71                  | 1729                   |
| Al-BWEP-Al    | 0.64                  | 1646                   |
| Pb-WEP-Pb     | 0.94                  | 1670                   |
| Pb-BWEP-Pb    | 0.91                  | 1729                   |
| Water         | 31.0                  | 1223                   |

TABLE 9A

FAST FLUX\*

| <u>Shield</u> | <u>Measured**</u>    | <u>ANISN</u>         | <u>SABINE</u>        |
|---------------|----------------------|----------------------|----------------------|
| Fe-WEP-Fe     | $5.7 \times 10^{-7}$ | $9.1 \times 10^{-7}$ | $6.1 \times 10^{-4}$ |
| Fe-BWEP-Fe    | $4.5 \times 10^{-7}$ | $9.0 \times 10^{-7}$ | $6.1 \times 10^{-4}$ |
| Al-WEP-Al     | $1.4 \times 10^{-6}$ | $1.8 \times 10^{-6}$ | $1.7 \times 10^{-3}$ |
| Al-BWEP-Al    | $1.7 \times 10^{-6}$ | $1.8 \times 10^{-6}$ | $1.7 \times 10^{-3}$ |
| Pb-WEP-Pb     | $1.1 \times 10^{-6}$ | $1.4 \times 10^{-6}$ | $1.1 \times 10^{-3}$ |
| Pb-BWEP-Pb    | $9.9 \times 10^{-7}$ | $1.4 \times 10^{-6}$ | $1.1 \times 10^{-3}$ |
| Water         | $1.2 \times 10^{-5}$ | $2.2 \times 10^{-5}$ | $8.6 \times 10^{-3}$ |

\* All values are given in units of  $n\text{-cm}^{-2}\text{sec}^{-1}$  per source neutron as determined by  $^{32}\text{S}(n,p)^{32}\text{P}$  threshold reaction.

\*\* Experimental error is estimated to be within  $\pm 25\%$  due to combined errors in the average cross section and counting statistics.

TABLE 9B

FAST FLUX RATIOS

| <u>Shield</u> | <u>ANISN/Measured</u> | <u>SABINE/Measured</u> |
|---------------|-----------------------|------------------------|
| Fe-WEP-Fe     | 1.6                   | 1085                   |
| Fe-BWEP-Fe    | 2.0                   | 1356                   |
| Al-WEP-Al     | 1.3                   | 1218                   |
| Al-BWEP-Al    | 1.1                   | 1036                   |
| Pb-WEP-Pb     | 1.3                   | 991                    |
| Pb-BWEP-Pb    | 1.4                   | 1137                   |
| Water         | 1.8                   | 702                    |

tend to support this explanation. The ANISN model adequately describes the geometry and the boundary conditions for the homogeneous medium. Thus in this situation, ANISN calculated a thermal flux value which is in good agreement with the experimentally-determined result. The tremendous errors in the SABINE calculations for the laminated shields are probably due to the breakdown of diffusion theory near interfaces in materials with vastly different neutron physics properties. This hypothesis is supported by the results of the "infinite" water experiment where no interfaces or boundaries are present and the error in the SABINE answer is reduced. Another possible source of error could be that the individual slab shield thicknesses were thin in comparison to the thermal neutron slowing down length and thermal diffusion parameters.

The resonance flux ratios given in Table 8B indicate that ANISN predicted the resonance flux much better than SABINE for the laminated shielding cases. However, for the "infinite" water medium, the ANISN value is high by a factor of 31. This divergence from ANISN results in the laminated cases is difficult to explain. The  $\pm 50\%$  error given for the resonance flux measurements is based upon a conservative estimate due to uncertainties in the average resonance activation cross section. Also considering uncertainties due to self-shielding, foil thicknesses, and detector orientation an experimental error in excess of 50% is possible. In any event, the ANISN results were still much closer to the measured fluxes than were the SABINE values.

The fast neutron flux ( $E_n > 3.0$  MeV) measured represents the uncollided portion of the source neutrons. In both the laminated and "infinite" medium cases, ANISN predicted fast fluxes within a factor of two of the

measured values. The best SABINE fast flux result is greater than 700 times the measured flux. Once again the experimental error quoted is based on a conservative estimate considering uncertainties in the average cross section. Other sources of error such as counting statistics, counting efficiency, and detector orientation could possibly contribute to a greater error.

Data gathered in this study would support a conclusion that SABINE calculations are not accurate. However, work performed by West<sup>(9)</sup> and Ponti<sup>(13)</sup> using the SABINE code resulted in different conclusions. West used ANISN and SABINE to perform calculations of the gamma and neutron fluxes penetrating the shielding of a typical commercial light water reactor. West did not quote the neutron flux values calculated, but concluded that the SABINE calculations compare "favorably" with the ANISN calculations. Ponti performed SABINE calculations and compared his results with experimental measurements made at the Forschungs-Reaktor Geesthacht reactor. This reactor is a 1 MW, swimming pool-type with MTR-type fuel elements. Ponti studied several shielding arrangements, but only the data from his infinite water medium experiment can be compared to this paper's results. At 20 cm. from the source in the water Ponti obtained SABINE/measurement ratios of approximately 1.0 for thermal neutrons, 0.7 for epithermal neutrons, and 1.1 for fast neutrons. In comparison to the SABINE/measured flux ratio results presented earlier in this paper, Ponti's results are remarkable. One basic difference between the two SABINE calculations is with respect to the source geometry. Ponti had a volume distributed source which he modeled using a "disk geometry." That is, a thin cylindrical source radiating in the azimuthal direction shielded by

a cylindrical shield. During discussion of his SABINE calculations Ponti did not specify what boundary condition was used at the source-shield interface. This factor brings up an important point concerning SABINE. Early in this thesis study it was learned, by trial and error, that if the group boundary fluxes at the source-shield interface are input as zeroes, SABINE calculated answers that were compatible with the measurements. Consequently, the wrong input could be used in SABINE and what appears to be good answers can be obtained. These arguments do not refute Ponti's results. Both he and West have been successful in treating specific problems; but, in this study SABINE has been disappointing. There are a number of possible sources of error in using SABINE and further work in determining these is warranted.

It is important to discuss some other factors in the analysis of the ANISN and SABINE comparison. One such factor is the computer hardware and software necessary to run these two codes. Both ANISN and SABINE require approximately 250K bytes of high-speed core to run in the overlay mode on the I.B.M. 360/65 computer system. For the "infinite" water medium problem both codes used about two minutes of central processing unit(C.P.U.) time. However, for the laminated shields ANISN completed each problem in an average time of 3.03 C.P.U. minutes, while SABINE needed an average of 6.8 C.P.U. minutes. But, to complete an ANISN calculation requires an extra step or job to prepare cross-section data. This increases the over-all C.P.U. time required to run an ANISN job, however a given set of cross sections can be used for several calculations. Another consideration when comparing the relative worth of the codes is their flexibility. From previous discussion it was noted that SABINE can

describe more complex geometries. However, it is restricted to just shielding calculations. On the other hand, ANISN can be used to perform criticality calculations as well as shielding analyses. Also, the ANISN code can use more complete libraries of cross-section data than can SABINE.

From the final analysis of the results of this study, some general conclusions can be made in regard to ANISN and SABINE. These conclusions are:

1. The discrete-ordinates code, ANISN, is considerably more accurate than the removal-diffusion code, SABINE, for the problems considered in this thesis.
2. The ANISN code cannot adequately handle complex geometries, but the resulting errors may be tolerable for flux estimations.
3. Considering other factors such as computer core storage, C.P.U. time, and code flexibility, ANISN appears to be superior to SABINE.
4. To isolate the reasons for the large discrepancies in the SABINE results further work should be done.



## REFERENCES

1. B.G. Carlson, "Numerical Formulation and Solution of Neutron Transport Problems," LA-2996, November 11, 1963.
2. "Revised WANL ANISN Program User's Manual", Radiation Shielding Information Center, CCC 82-D, Oak Ridge National Laboratory, 1967.
3. K.D. Lathrop, "Discrete-Ordinates Methods for the Numerical Solution of the Transport Equation", Reactor Technology, Vol. 15, No. 2, Summer 1972.
4. "100G: 100-Group Neutron Transport Code Cross Section Data Based on ENDF/B", Radiation Shielding Information Center, Oak Ridge National Laboratory, July, 1972.
5. D.H. Stoddard, H.E. Hootman, "Cf-252 Shielding Guide", E.I. du Pont de Nemours and Company, DP-1246, March, 1971.
6. A.F. Avery, D.E. Bendall, J. Butler, K.T. Spinney, "Methods of Calculation for Use in Design of Shields for Power Reactors", AERE-R 3216, 1960.
7. P.N. Stevens, D.K. Trubey, "Methods for Calculating Neutron and Gamma-Ray Attenuation", Chapter 3 of Weapons Radiation Shielding Handbook, DNA-1892-3 Rev. 1. April, 1971.
8. C. Ponti, "SABINE Spinney (Removal-Diffusion) Shielding Code In Complex Geometry", EUR 3636.e, EURATOM, 1967.
9. J.T. West, "Removal-Diffusion Theory vs. Transport Theory in Shielding Design; a SABINE-ANISN Comparison", Transactions of the American Nuclear Society, Vol. 18, pp. 398-99, June, 1974.

10. H.M. Murphy, "Summary of Neutron and Gamma Dosimetry Techniques", Air Force Weapons Laboratory, AFWL, TR-66-111, September, 1967.
11. J.E. Morel, "A Comparison of Calculated and Measured Cf-252 Neutron Spectra", Master's Thesis, Louisiana State University, May, 1974.
12. T.A. Greene, "Biological Applications of Californium-252: Utilization and Dosimetry of an Irradiation Facility and Design of an Irradiation Assembly For Use with Small Biological Targets", Master's Thesis, Louisiana State University, May, 1974.
13. R. Nicks, G. Perlini, C. Ponti, "SABINE: A One-Dimensional Shielding Programme which Employs Experimental Removal Cross-Sections", AERE-5773 (Vol. 1), pp. 5-40, September, 1967.
14. W.W. Engle, Jr., "ANISN - A One Dimensional Discrete Ordinates Transport Code With Anisotropic Scattering", K-1693, Oak Ridge National Laboratory, 1967.
15. W.J. Price, Nuclear Radiation Detection, 2 nd. ed., McGraw-Hill, New York, 1964.

## APPENDIX A

## INPUT FOR ANISN AND SABINE

ANISN and SABINE are both run in the overlay mode of the link editor on the I.B.M. 360/65 O.S. Presently, both codes require approximately 260K bytes of high speed core to run. Central processing unit time necessary to run a job on either code depends on the complexity of the job. The compiled version of ANISN named ANISN.M resides on file 1 of a standard label magnetic tape, T1522. This is the only tape necessary to run an ANISN job. The Fortran version of SABINE resides on file 2 of a standard label magnetic tape, T1927. The data library named SABINE.LIBRARY resides on file 1 of magnetic tape T1929. Both of these tapes are needed to run a SABINE job. On the following pages the input for the "infinite" water problem used by ANISN and SABINE are listed.

```

//ANISNR JOB (260,7011,9,5),50853 ROBERT*
// EXEC FORTGLG,PARM.LKED=(XREF,LET,LIST,OVLY).
// REGION.GO=260K,TIME=9
//LKED.SYSIN DD UNIT=TAPE,DSN=ANISN.M.COMPILED,LABEL=(1,SL),
// DISP=OLD,VOL=SER=T1522
// DD *
ENTRY MAIN
OVERLAY LEVEL 1
INSERT PLSNT,F100,TP,ADJNT,S804,S805,S814,WOT8,S966
OVERLAY LEVEL 1
INSERT GUTS,S807,S810,S821,S824,S833,DT,CELL,S851
OVERLAY LEVEL 1
INSERT FINPR,FINPR1,PUNSH,DTFPUN,FLTFX
OVERLAY LEVEL 2
INSERT BT,SUMMARY,FACTOR
OVERLAY LEVEL 2
INSERT FEWG,WATE
OVERLAY LEVEL 3(REGION)
//GO.FT01F001 DD UNIT=SYSDA,SPACE=(TRK,(800,100),RLSE),
// DCR=(RECFM=VBS,LRECL=3516,BLKSIZE=3520)
//GO.FT02F001 DD UNIT=SYSDA,SPACE=(TRK,(800,100),RLSE),
// DCR=(RECFM=VBS,LRECL=3516,BLKSIZE=3520)
//GO.FT04F001 DD DUMMY
//GO.FT08F001 DD DUMMY
//GO.FT09F001 DD DUMMY
//GO.SYSIN DD *
INF. HOMO. WATER RUN, 25GRP..P-5,S-16
15$ 1 1 0 5 16 3
2R 2 21 0 25 3
4 28 18 0 24
0 1 2R 0 500 4R 1
0 3 1 2R 0 1.0
2R 0 2R 0.0 4R 0.0 0.0
16* 0.0001 3R 0.0 T
0.5
14*

```

|     |         |         |         |         |         |         |         |         |         |         |         |   |
|-----|---------|---------|---------|---------|---------|---------|---------|---------|---------|---------|---------|---|
| 0   | +63044- | 7 0 +   | 0+ 0 0  | +11386- | 5 0     | +53682- | 624R+   | 0+ 0 0  | +11721- | 7       |         |   |
| 0   | +       | 0+ 0 0  | +13482- | 5 0     | +83089- | 6 0     | +20481- | 623R+   | 0+ 0 0  | +12967- | 8       |   |
| 0   | +       | 0+ 0 0  | +16696- | 5 0     | +12596- | 5 0     | +23114- | 6 0     | +11581- | 622R+   | 0+ 0    |   |
| 0   | +       | 0+ 0 0  | 0+ 0 0  | +18288- | 5 0     | +14902- | 5 0     | +23869- | 6 0     | +12124- | 6       |   |
| 0   | +       | 0+ 0 0  | 0+ 0 0  | +95938- | 10 0    | 0+      | 0+      | +20116- | 5 0     | +16884- | 5       |   |
| 0   | +       | 0+ 0 0  | +68127- | 7 0     | +89342- | 7 0     | +56715- | 720R+   | 0+ 0 0  | +19985- | 9       |   |
| 0   | +       | 0+ 0 0  | +23901- | 5 0     | +21529- | 5 0     | +25867- | 6 0     | +72358- | 7 0     | +41447- | 7 |
| 0   | +       | 0+ 0 0  | +31998- | 719R+   | 0+      | 0+      | +46953- | 9 0     | 0+      | 0+      | +24043- | 5 |
| 0   | +       | 0+ 0 0  | +23702- | 6 0     | +13410- | 7 0     | +36317- | 7 0     | +31604- | 7 0     | +10986- | 7 |
| 0   | +       | 0+ 0 0  | 0+ 0 0  | +49491- | 9 0     | 0+      | 0+      | 0+      | +25496- | 5 0     | +22110- | 5 |
| 0   | +       | 0+ 0 0  | 0+ 0 0  | +27912- | 7 0     | +31004- | 8 0     | +15601- | 7 0     | +66151- | 8       |   |
| 0   | +       | 0+ 0 0  | 0+ 0 0  | +14478- | 8 0     | 0+      | 0+      | +42117- | 5 0     | +34677- | 5       |   |
| 0   | +       | 0+ 0 0  | 0+ 0 0  | +16974- | 7 0     | 0+      | 0+      | +10102- | 7 0     | +41967- | 8       |   |
| 0   | +       | 0+ 0 0  | 0+ 0 0  | +31904- | 8 0     | 0+      | 0+      | +37925- | 5 0     | +31655- | 5       |   |
| 0   | +       | 0+ 0 0  | 0+ 0 0  | +53281- | 8 0     | 0+      | 0+      | +27433- | 8 0     | +14812- | 8       |   |
| 0   | +       | 0+ 0 0  | 0+ 0 0  | +19339- | 8 0     | 0+      | 0+      | +64961- | 6 0     | +59247- | 6       |   |
| 0   | +       | 0+ 0 0  | 0+ 0 0  | +61099- | 9 0     | 0+      | 0+      | +34358- | 9 0     | +22149- | 9       |   |
| 0   | +       | 0+ 0 0  | 0+ 0 0  | +76267- | 8 0     | 0+      | 0+      | +10717- | 5 0     | +99977- | 6       |   |
| 0   | +       | 0+ 0 0  | 0+ 0 0  | +12103- | 9 0     | 0+      | 0+      | +33541- | 10 0    | +10344- | 10      |   |
| 0   | +       | 0+ 0 0  | 0+ 0 0  | +20772- | 8 0     | 0+      | 0+      | +91218- | 6 0     | +84289- | 6       |   |
| 0   | +       | 0+ 0 0  | 0+ 0 0  | +30900- | 10 0    | 0+      | 0+      | +41697- | 12 0    | 0+      | 0+      |   |
| 0   | +       | 0+ 0 0  | 0+ 0 0  | +12083- | 8 0     | 0+      | 0+      | +91910- | 6 0     | +85114- | 6       |   |
| 0   | +       | 0+ 0 0  | 0+ 0 0  | +95194- | 12 3R+  | 0+      | 0+      | +68070- | 1411R+  | 0+      | 0+      |   |
| 0   | +       | 0+ 0 0  | 0+ 0 0  | +91440- | 6 0     | +84640- | 6 0     | +66737- | 712R+   | 0+      | 0+      |   |
| 0   | +       | 0+ 0 0  | 0+ 0 0  | +20692- | 8 0     | 0+      | 0+      | +91315- | 6 0     | +84458- | 6       |   |
| 0   | +       | 0+ 0 0  | 0+ 0 0  | +32505- | 8 0     | 0+      | 0+      | +91716- | 6 0     | +84714- | 6       |   |
| 0   | +       | 0+ 0 0  | 0+ 0 0  | +53654- | 8 0     | 0+      | 0+      | +92139- | 6 0     | +84917- | 6       |   |
| 0   | +       | 0+ 0 0  | 0+ 0 0  | +82739- | 8 0     | 0+      | 0+      | +92311- | 6 0     | +82601- | 6       |   |
| 0   | +       | 0+ 0 0  | 0+ 0 0  | +11265- | 7 0     | 0+      | 0+      | +92375- | 6 0     | +77945- | 6       |   |
| 0   | +       | 0+ 0 0  | 0+ 0 0  | +14456- | 7 0     | 0+      | 0+      | +92586- | 6 0     | +77851- | 6       |   |
| 0   | +       | 0+ 0 0  | 0+ 0 0  | +18551- | 7 0     | 0+      | 0+      | +92930- | 6 0     | +77793- | 6       |   |
| 0   | +       | 0+ 0 0  | 0+ 0 0  | +23815- | 7 0     | 0+      | 0+      | +93427- | 6 0     | +77764- | 6       |   |
| 0   | +       | 0+ 0 0  | 0+ 0 0  | +30595- | 7 0     | 0+      | 0+      | +94101- | 6 0     | +77760- | 6       |   |
| 0   | +       | 0+ 0 0  | 0+ 0 0  | +12411- | 6 0     | 0+      | 0+      | +10345- | 5 0     | +91038- | 6       |   |
| 0   | +       | 0+ 0 0  | 0+ 0 0  | 0+ 0 0  | 0+ 0 0  | 0+ 0 0  | 0+ 0 0  | 0+ 0 0  | 0+ 0 0  | 0+ 0 0  | 0+ 0    |   |
| 3R+ | 0+ 0 0  | +10387- | 527R+   | 0+ 0 0  | +14303- | 5 0     | -38010- | 726R+   | 0+ 0    | 0+ 0    | 1       |   |



|     |         |       |    |         |        |   |         |        |
|-----|---------|-------|----|---------|--------|---|---------|--------|
| 0   | +19663- | 5     | 0  | +17966- | 826R+  |   |         |        |
| 0   | +20118- | 5     | 0  | -49379- | 726R+  |   |         |        |
| 0   | +12237- | 5     | 0  | -16404- | 626R+  |   |         |        |
| 0   | +10764- | 5     | 0  | -35637- | 626R+  |   |         |        |
| 0   | +10402- | 6     | 0  | -86157- | 626R+  |   |         |        |
| 0   | +13188- | 6     | 0  | -61216- | 726R+  |   |         |        |
| 0   | +13140- | 6     | 0  | -63380- | 726R+  |   |         |        |
| 0   | +13171- | 6     | 0  | -63131- | 726R+  |   |         |        |
| 0   | +15275- | 6     | 0  | -63473- | 726R+  |   |         |        |
| 0   | +19435- | 6     | 0  | -12633- | 626R+  |   |         |        |
| 0   | +19420- | 6     | 0  | -12608- | 626R+  |   |         |        |
| 0   | -12612- | 623R+ | 0+ |         |        |   |         |        |
| 3R+ | 0+      | 0     | 0  | +13491- | 527R+  |   |         |        |
| 0   | +16954- | 5     | 0  | +13709- | 726R+  |   |         |        |
| 0   | +10826- | 5     | 0  | -45710- | 726R+  |   |         |        |
| 0   | +33816- | 6     | 0  | -58185- | 726R+  |   |         |        |
| 0   | +23059- | 6     | 0  | +46849- | 726R+  |   |         |        |
| 0   | -16923- | 8     | 0  | +19948- | 626R+  |   |         |        |
| 0   | +41670- | 8     | 0  | -30134- | 826R+  |   |         |        |
| 0   | +41420- | 8     | 0  | -33058- | 826R+  |   |         |        |
| 0   | +41622- | 8     | 0  | -33136- | 826R+  |   |         |        |
| 0   | +52462- | 8     | 0  | -33223- | 826R+  |   |         |        |
| 0   | +74400- | 8     | 0  | -66010- | 826R+  |   |         |        |
| 0   | +74129- | 8     | 0  | -66766- | 826R+  |   |         |        |
| 0   | -65706- | 823R+ | 0+ |         |        |   |         |        |
| 3R+ | 0+      | 0     | 0  | +12113- | 527R+  |   |         |        |
| 0   | +71274- | 6     | 0  | -62657- | 726R+  |   |         |        |
| 0   | +23365- | 6     | 0  | -65097- | 726R+  |   |         |        |
| 0   | +35629- | 7     | 0  | -12659- | 726R+  |   |         |        |
| 0   | +21398- | 7     | 0  | -17066- | 726R+  |   |         |        |
| 0   | +25646- | 8     | 0  | +11133- | 626R+  |   |         |        |
| 0   | +46350- | 10    | 0  | -39995- | 1026R+ |   |         |        |
| 0   | +46935- | 10    | 0  | -46917- | 1026R+ |   |         |        |
| 0   | +47337- | 10    | 0  | -47349- | 1026R+ |   |         |        |
| 0   | +62564- | 10    | 0  | -47331- | 1026R+ |   |         |        |
| 0   | +93872- | 10    | 0  | -93863- | 1026R+ |   |         |        |
| 2   | 0       | 0     | 0  | +18954- | 5      | 0 | -67902- | 926R+  |
| 3   | 0       | 0     | 0  | +19162- | 5      | 0 | -72551- | 726R+  |
| 4   | 0       | 0     | 0  | +90705- | 6      | 0 | -25081- | 626R+  |
| 5   | 0       | 0     | 0  | +11449- | 5      | 0 | -62683- | 626R+  |
| 6   | 0       | 0     | 0  | +14076- | 6      | 0 | -55597- | 726R+  |
| 7   | 0       | 0     | 0  | +13201- | 6      | 0 | -63838- | 726R+  |
| 8   | 0       | 0     | 0  | +13125- | 6      | 0 | -63142- | 726R+  |
| 9   | 0       | 0     | 0  | +13196- | 6      | 0 | -63381- | 726R+  |
| 10  | 0       | 0     | 0  | +19455- | 6      | 0 | -84352- | 726R+  |
| 11  | 0       | 0     | 0  | +19418- | 6      | 0 | -12620- | 626R+  |
| 12  | 0       | 0     | 0  | +19419- | 6      | 0 | -12613- | 627R+  |
| 13  | 0       | 0     | 0  |         |        |   |         |        |
| 1   | 0       | 0     | 0  | +14846- | 5      | 0 | +75952- | 726R+  |
| 2   | 0       | 0     | 0  | +12507- | 5      | 0 | +10660- | 726R+  |
| 3   | 0       | 0     | 0  | +75561- | 6      | 0 | -10478- | 626R+  |
| 4   | 0       | 0     | 0  | +58649- | 7      | 0 | -90715- | 726R+  |
| 5   | 0       | 0     | 0  | -19864- | 6      | 0 | -18314- | 626R+  |
| 6   | 0       | 0     | 0  | +38559- | 8      | 0 | +25344- | 826R+  |
| 7   | 0       | 0     | 0  | +41479- | 8      | 0 | -33249- | 826R+  |
| 8   | 0       | 0     | 0  | +41557- | 8      | 0 | -32997- | 826R+  |
| 9   | 0       | 0     | 0  | +41643- | 8      | 0 | -33199- | 826R+  |
| 10  | 0       | 0     | 0  | +74430- | 8      | 0 | -44041- | 826R+  |
| 11  | 0       | 0     | 0  | +75186- | 8      | 0 | -65977- | 826R+  |
| 12  | 0       | 0     | 0  | +74129- | 8      | 0 | -65706- | 827R+  |
| 13  | 0       | 0     | 0  |         |        |   |         |        |
| 1   | 0       | 0     | 0  | +92532- | 6      | 0 | -61659- | 726R+  |
| 2   | 0       | 0     | 0  | +33847- | 6      | 0 | -11601- | 626R+  |
| 3   | 0       | 0     | 0  | +80632- | 7      | 0 | -82148- | 726R+  |
| 4   | 0       | 0     | 0  | +24177- | 7      | 0 | -17640- | 726R+  |
| 5   | 0       | 0     | 0  | -11133- | 6      | 0 | -67958- | 826R+  |
| 6   | 0       | 0     | 0  | +39995- | 10     | 0 | -25646- | 826R+  |
| 7   | 0       | 0     | 0  | +46917- | 10     | 0 | -46350- | 1026R+ |
| 8   | 0       | 0     | 0  | +47349- | 10     | 0 | -46935- | 1026R+ |
| 9   | 0       | 0     | 0  | +47331- | 10     | 0 | -47337- | 1026R+ |
| 10  | 0       | 0     | 0  | +93863- | 10     | 0 | -62564- | 1026R+ |
| 11  | 0       | 0     | 0  | -13986- | 10     | 0 | -93872- | 1026R+ |

|     |         |        |    |         |         |    |         |         |         |       |    |         |         |         |         |    |   |
|-----|---------|--------|----|---------|---------|----|---------|---------|---------|-------|----|---------|---------|---------|---------|----|---|
| 0   | +14224- | 9      | 0  | +13986- | 1026R+  | 0+ | 0       | 0       | +14223- | 9     | 0  | -14224- | 927R+   | 0+      | 0       | 12 |   |
| 0   | -14223- | 923R+  | 0+ | 0       |         |    |         |         |         |       |    |         |         |         |         | 13 |   |
| 3R+ | 0+      | 0      | 0  | +11033- | 527R+   | 0+ | 0       | 0       | +59300- | 6     | 0  | +36600- | 726R+   | 0+      | 0       | 1  |   |
| 0   | +27404- | 6      | 0  | -14919- | 726R+   | 0+ | 0       | 0       | +49353- | 7     | 0  | -18900- | 726R+   | 0+      | 0       | 2  |   |
| 0   | +12128- | 7      | 0  | -42069- | 826R+   | 0+ | 0       | 0       | -13398- | 7     | 0  | -88033- | 926R+   | 0+      | 0       | 3  |   |
| 0   | -12797- | 7      | 0  | +17061- | 726R+   | 0+ | 0       | 0       | +22115- | 7     | 0  | +14080- | 726R+   | 0+      | 0       | 4  |   |
| 0   | -11297- | 7      | 0  | -21615- | 726R+   | 0+ | 0       | 0       | +94012- | 7     | 0  | +15263- | 726R+   | 0+      | 0       | 5  |   |
| 0   | -39187- | 10     | 0  | -94014- | 726R+   | 0+ | 0       | 0       | -43564- | 11    | 0  | +39012- | 1026R+  | 0+      | 0       | 6  |   |
| 0   | -32631- | 11     | 0  | +42319- | 1126R+  | 0+ | 0       | 0       | -44940- | 11    | 0  | +30950- | 1126R+  | 0+      | 0       | 7  |   |
| 0   | -44773- | 11     | 0  | +43259- | 1126R+  | 0+ | 0       | 0       | -44748- | 11    | 0  | +43092- | 1126R+  | 0+      | 0       | 8  |   |
| 0   | -44853- | 11     | 0  | +43067- | 1126R+  | 0+ | 0       | 0       | -45005- | 11    | 0  | +43172- | 1126R+  | 0+      | 0       | 9  |   |
| 0   | -59244- | 11     | 0  | +43324- | 1126R+  | 0+ | 0       | 0       | -87932- | 11    | 0  | +57563- | 1126R+  | 0+      | 0       | 10 |   |
| 0   | -87748- | 11     | 0  | +86251- | 1126R+  | 0+ | 0       | 0       | +13725- | 9     | 0  | +86067- | 1126R+  | 0+      | 0       | 11 |   |
| 0   | -60060- | 10     | 0  | -13742- | 926R+   | 0+ | 0       | 0       | -60060- | 10    | 0  | +59891- | 1027R+  | 0+      | 0       | 12 |   |
| 0   | +59891- | 1023R+ | 0+ | 0       |         |    |         |         |         |       |    |         |         |         |         | 13 |   |
| 3R+ | 0+      | 0      | 0  | +73790- | 627R+   | 0+ | 0       | 0       | +30665- | 6     | 0  | -34317- | 726R+   | 0+      | 0       | 1  |   |
| 0   | +44734- | 7      | 0  | -17689- | 726R+   | 0+ | 0       | 0       | -32761- | 8     | 0  | -11357- | 726R+   | 0+      | 0       | 2  |   |
| 0   | -30031- | 8      | 0  | +72367- | 826R+   | 0+ | 0       | 0       | +95305- | 8     | 0  | +34078- | 826R+   | 0+      | 0       | 3  |   |
| 0   | -13667- | 7      | 0  | -10693- | 726R+   | 0+ | 0       | 0       | -14643- | 7     | 0  | +11834- | 726R+   | 0+      | 0       | 4  |   |
| 0   | -11890- | 7      | 0  | +12397- | 726R+   | 0+ | 0       | 0       | -65547- | 10    | 0  | +11929- | 726R+   | 0+      | 0       | 5  |   |
| 0   | -11552- | 8      | 0  | +65547- | 1026R+  | 0+ | 0       | 0       | -34551- | 10    | 0  | +11552- | 826R+   | 0+      | 0       | 6  |   |
| 0   | -37726- | 10     | 0  | +34551- | 1026R+  | 0+ | 0       | 0       | -36218- | 10    | 0  | +37726- | 1026R+  | 0+      | 0       | 7  |   |
| 0   | -36100- | 10     | 0  | +36218- | 1026R+  | 0+ | 0       | 0       | -36123- | 10    | 0  | +36100- | 1026R+  | 0+      | 0       | 8  |   |
| 0   | -36263- | 10     | 0  | +36123- | 1026R+  | 0+ | 0       | 0       | -36302- | 10    | 0  | +36263- | 1026R+  | 0+      | 0       | 9  |   |
| 0   | -48208- | 10     | 0  | +36302- | 1026R+  | 0+ | 0       | 0       | -72207- | 10    | 0  | +48208- | 1026R+  | 0+      | 0       | 10 |   |
| 0   | -72161- | 10     | 0  | +72207- | 1026R+  | 0+ | 0       | 0       | -24756- | 9     | 0  | +72161- | 1026R+  | 0+      | 0       | 11 |   |
| 0   | -92381- | 12     | 0  | +24756- | 926R+   | 0+ | 0       | 0       | -90893- | 12    | 0  | +92381- | 1227R+  | 0+      | 0       | 12 |   |
| 0   | +90893- | 1223R+ | 0+ | 0       |         |    |         |         |         |       |    |         |         |         |         | 13 |   |
| 0   | +34509- | 9      | 0  | 0       | +12082- | 4  | 0       | +19950- | 524R+   | 0+    | 0  | 0       | +36219- | 9       |         | 1  |   |
| 0   | 0       | 0      | 0  | +17360- | 4       | 0  | +32046- | 5       | +39691- | 523R+ | 0+ | 0       | 0       | +35367- | 9       | 2  |   |
| 0   | 0       | 0      | 0  | +23835- | 4       | 0  | +46220- | 5       | +55697- | 5     | 0  | +24074- | 522R+   | 0+      | 0       | 3  |   |
| 0   | +34333- | 9      | 0  | 0       | 0       | 0  | +31582- | 4       | +65404- | 5     | 0  | +75598- | 5       | 0       | +33782- | 5  | 4 |
| 0   | +14601- | 521R+  | 0+ | 0       | 0       | 0  | +34518- | 9       | 0       | 0     | 0  | +41392- | 4       | 0       | +86581- | 5  | 5 |
| 0   | +98531- | 5      | 0  | +45852- | 5       | 0  | +20490- | 5       | +88561- | 620R+ | 0+ | 0       | 0       | 0       | +36178- | 9  | 6 |
| 0   | 0       | 0      | 0  | +53610- | 4       | 0  | +11705- | 4       | +12880- | 4     | 0  | +59761- | 5       | 0       | +27811- | 5  | 7 |
| 0   | +12428- | 5      | 0  | +53715- | 619R+   | 0+ | 0       | 0       | +42494- | 9     | 0  | 0       | 0       | 0       | +70336- | 4  | 8 |



|   |         |    |      |         |    |      |         |   |   |         |    |      |         |    |      |         |    |    |
|---|---------|----|------|---------|----|------|---------|---|---|---------|----|------|---------|----|------|---------|----|----|
| 0 | +14205- | 4  | 0    | +16488- | 4  | 0    | +78121- | 5 | 0 | +36247- | 5  | 0    | +16868- | 5  | 0    | +75378- | 6  | 9  |
| 0 | +32580- | 6  | 18R+ | 0+      | 0  | 0    | +56421- | 9 | 0 | +       | 0+ | 0    | +89337- | 4  | 0    | +19149- | 4  | 10 |
| 0 | +22086- | 4  | 0    | +10001- | 4  | 0    | +47382- | 5 | 0 | +21985- | 5  | 0    | +10231- | 5  | 0    | +45718- | 6  | 11 |
| 0 | +19761- | 6  | 17R+ | 0+      | 0  | 0    | +90047- | 9 | 0 | +       | 0+ | 0    | +11648- | 3  | 0    | +34530- | 4  | 12 |
| 0 | +37033- | 4  | 0    | +17963- | 4  | 0    | +81340- | 5 | 0 | +38538- | 5  | 0    | +17881- | 5  | 0    | +83214- | 6  | 13 |
| 0 | +37185- | 6  | 0    | +16072- | 6  | 16R+ | 0+      | 0 | 0 | +17083- | 8  | 0    | +       | 0+ | 0    | +15244- | 3  | 14 |
| 0 | +56012- | 4  | 0    | +51801- | 4  | 0    | +20957- | 4 | 0 | +10166- | 4  | 0    | +46031- | 5  | 0    | +21809- | 5  | 15 |
| 0 | +10119- | 5  | 0    | +47091- | 6  | 0    | +21043- | 6 | 0 | +90954- | 7  | 15R+ | 0+      | 0  | 0    | +33434- | 8  | 16 |
| 0 | +       | 0+ | 0    | +18108- | 3  | 0    | +66323- | 4 | 0 | +60955- | 4  | 0    | +19056- | 4  | 0    | +77098- | 5  | 17 |
| 0 | +37397- | 5  | 0    | +16934- | 5  | 0    | +80232- | 6 | 0 | +37227- | 6  | 0    | +17324- | 6  | 0    | +77415- | 7  | 18 |
| 0 | +33460- | 7  | 14R+ | 0+      | 0  | 0    | +61027- | 8 | 0 | +       | 0+ | 0    | +19512- | 3  | 0    | +71834- | 4  | 19 |
| 0 | +72541- | 4  | 0    | +22424- | 4  | 0    | +70105- | 5 | 0 | +28363- | 5  | 0    | +13758- | 5  | 0    | +62296- | 6  | 20 |
| 0 | +29516- | 6  | 0    | +13695- | 6  | 0    | +63731- | 7 | 0 | +28479- | 7  | 0    | +12309- | 7  | 13R+ | 0+      | 0  | 21 |
| 0 | +10496- | 7  | 0    | +       | 0+ | 0    | +20099- | 3 | 0 | +73763- | 4  | 0    | +77928- | 4  | 0    | +26686- | 4  | 22 |
| 0 | +82493- | 5  | 0    | +25790- | 5  | 0    | +10434- | 5 | 0 | +50611- | 6  | 0    | +22917- | 6  | 0    | +10858- | 6  | 23 |
| 0 | +50381- | 7  | 0    | +23445- | 7  | 0    | +10477- | 7 | 0 | +45284- | 8  | 12R+ | 0+      | 0  | 0    | +17144- | 7  | 24 |
| 0 | +       | 0+ | 0    | +20318- | 3  | 0    | +74682- | 4 | 0 | +80420- | 4  | 0    | +28668- | 4  | 0    | +98173- | 5  | 25 |
| 0 | +30348- | 5  | 0    | +94877- | 6  | 0    | +38385- | 6 | 0 | +18619- | 6  | 0    | +84308- | 7  | 0    | +39945- | 7  | 26 |
| 0 | +18534- | 7  | 0    | +86251- | 8  | 0    | +38542- | 8 | 0 | +16659- | 8  | 11R+ | 0+      | 0  | 0    | +28269- | 7  | 27 |
| 0 | +       | 0+ | 0    | +20386- | 3  | 0    | +74959- | 4 | 0 | +81214- | 4  | 0    | +29585- | 4  | 0    | +10546- | 4  | 28 |
| 0 | +36116- | 5  | 0    | +11164- | 5  | 0    | +34903- | 6 | 0 | +14121- | 6  | 0    | +68495- | 7  | 0    | +31015- | 7  | 29 |
| 0 | +14695- | 7  | 0    | +68183- | 8  | 0    | +31730- | 8 | 0 | +14179- | 8  | 0    | +61285- | 9  | 10R+ | 0+      | 0  | 30 |
| 0 | +46723- | 7  | 0    | +       | 0+ | 0    | +20438- | 3 | 0 | +75149- | 4  | 0    | +81464- | 4  | 0    | +29877- | 4  | 31 |
| 0 | +10884- | 4  | 0    | +38798- | 5  | 0    | +13286- | 5 | 0 | +41071- | 6  | 0    | +12840- | 6  | 0    | +51948- | 7  | 32 |
| 0 | +25198- | 7  | 0    | +11410- | 7  | 0    | +54059- | 8 | 0 | +25083- | 8  | 0    | +11673- | 8  | 0    | +52161- | 9  | 33 |
| 0 | +22545- | 9  | 9R+  | 0+      | 0  | 0    | +77087- | 7 | 0 | +       | 0+ | 0    | +20456- | 3  | 0    | +75228- | 4  | 34 |
| 0 | +81663- | 4  | 0    | +29969- | 4  | 0    | +10991- | 4 | 0 | +40039- | 5  | 0    | +14273- | 5  | 0    | +48878- | 6  | 35 |
| 0 | +15109- | 6  | 0    | +47236- | 7  | 0    | +19111- | 7 | 0 | +92697- | 8  | 0    | +41974- | 8  | 0    | +19887- | 8  | 36 |
| 0 | +92276- | 9  | 0    | +42942- | 9  | 0    | +19189- | 9 | 0 | +82939- | 10 | 8R+  | 0+      | 0  | 0    | +12711- | 6  | 37 |
| 0 | +       | 0+ | 0    | +20462- | 3  | 0    | +75228- | 4 | 0 | +81710- | 4  | 0    | +30042- | 4  | 0    | +11025- | 4  | 38 |
| 0 | +40434- | 5  | 0    | +14730- | 5  | 0    | +52507- | 6 | 0 | +17981- | 6  | 0    | +55584- | 7  | 0    | +17377- | 7  | 39 |
| 0 | +70304- | 8  | 0    | +34102- | 8  | 0    | +15442- | 8 | 0 | +73161- | 9  | 0    | +33946- | 9  | 0    | +15797- | 9  | 40 |
| 0 | +70593- | 10 | 0    | +30512- | 10 | 7R+  | 0+      | 0 | 0 | +19599- | 6  | 0    | +       | 0+ | 0    | +20468- | 3  | 41 |
| 0 | +60629- | 4  | 0    | +68203- | 4  | 0    | +25091- | 4 | 0 | +92250- | 5  | 0    | +33854- | 5  | 0    | +12416- | 5  | 42 |
| 0 | +45230- | 6  | 0    | +16123- | 6  | 0    | +55214- | 7 | 0 | +17068- | 7  | 0    | +53360- | 8  | 0    | +21588- | 8  | 43 |
| 0 | +10472- | 8  | 0    | +47417- | 9  | 0    | +22466- | 9 | 0 | +10424- | 9  | 0    | +48509- | 10 | 0    | +21677- | 10 | 44 |



|     |           |     |           |         |           |         |           |         |           |           |           |           |           |           |           |         |    |    |
|-----|-----------|-----|-----------|---------|-----------|---------|-----------|---------|-----------|-----------|-----------|-----------|-----------|-----------|-----------|---------|----|----|
| 0   | +93692-11 | 6R+ | 0+        | 0       | 0         | +26703- | 6         | 0       | +         | 0+        | 0         | 0         | +20475-   | 3         | 0         | +43569- | 4  | 45 |
| 0   | +56605-   | 4   | 0         | +24025- | 4         | 0       | +88383-   | 5       | 0         | +32496-   | 5         | 0         | +11925-   | 5         | 0         | +43736- | 6  | 46 |
| 0   | +15933-   | 6   | 0         | +56796- | 7         | 0       | +19450-   | 7       | 0         | +60123-   | 8         | 0         | +18797-   | 8         | 0         | +76046- | 9  | 47 |
| 0   | +36887-   | 9   | 0         | +16703- | 9         | 0       | +79137-10 | 0       | +36719-10 | 0         | +0+       | 0         | +17088-10 | 0         | +76358-11 |         | 48 |    |
| 0   | +33004-11 | 5R+ | 0+        | 0       | 0         | +34289- | 6         | 0       | +         | 0+        | 0         | 0         | +20483-   | 3         | 0         | +43569- | 4  | 49 |
| 0   | +63318-   | 4   | 0         | +34333- | 4         | 0       | +14572-   | 4       | 0         | +53607-   | 5         | 0         | +19710-   | 5         | 0         | +72331- | 6  | 50 |
| 0   | +26527-   | 6   | 0         | +96635- | 7         | 0       | +34449-   | 7       | 0         | +11797-   | 7         | 0         | +36467-   | 8         | 0         | +11401- | 8  | 51 |
| 0   | +46124-   | 9   | 0         | +22373- | 9         | 0       | +10131-   | 9       | 0         | +47999-10 | 0         | +22271-10 | 0         | +10364-10 |           |         | 52 |    |
| 0   | +46314-11 | 0   | +20018-11 | 4R+     | 0+        | 0       | 0         | 0       | +44030-   | 6         | 0         | +         | 0+        | 0         | +20493-   | 3       | 53 |    |
| 0   | +43569-   | 4   | 0         | +63318- | 4         | 0       | +38404-   | 4       | 0         | +20824-   | 4         | 0         | +88383-   | 5         | 0         | +32515- | 5  | 54 |
| 0   | +11954-   | 5   | 0         | +43871- | 6         | 0       | +16090-   | 6       | 0         | +58613-   | 7         | 0         | +20894-   | 7         | 0         | +71551- | 8  | 55 |
| 0   | +22118-   | 8   | 0         | +69149- | 9         | 0       | +27976-   | 9       | 0         | +13570-   | 9         | 0         | +61446-10 | 0         | +29113-10 |         | 56 |    |
| 0   | +13508-10 | 0   | +62861-11 | 0       | +28091-11 | 0       | +43569-   | 4       | 0         | +12141-11 | 3R+       | 0+        | 0         | 0         | +56537-   | 6       | 57 |    |
| 0   | +         | 0+  | 0         | 0       | +20506-   | 3       | 0         | +19721- | 5         | 0         | +63318-   | 4         | 0         | +38404-   | 4         | +23294- | 4  | 58 |
| 0   | +12630-   | 4   | 0         | +53607- | 5         | 0       | +19721-   | 5       | 0         | +72508-   | 6         | 0         | +26609-   | 6         | 0         | +97589- | 7  | 59 |
| 0   | +35550-   | 7   | 0         | +12673- | 7         | 0       | +43398-   | 8       | 0         | +13415-   | 8         | 0         | +41941-   | 9         | 0         | +16968- | 9  | 60 |
| 0   | +82306-10 | 0   | +37268-10 | 0       | +17658-10 | 0       | +81931-11 | 0       | +81931-11 | 0         | +38128-11 | 0         | +20521-   | 3         | 0         | +43569- | 4  | 61 |
| 0   | +73645-12 | 2R+ | 0+        | 0       | 0         | +72599- | 6         | 0       | +         | 0+        | 0         | 0         | +76607-   | 5         | 0         | +32515- | 5  | 62 |
| 0   | +63318-   | 4   | 0         | +38404- | 4         | 0       | +23294-   | 4       | 0         | +14128-   | 4         | 0         | +21562-   | 7         | 0         | +76865- | 8  | 63 |
| 0   | +11961-   | 5   | 0         | +43978- | 6         | 0       | +16139-   | 6       | 0         | +59191-   | 7         | 0         | +49921-10 | 0         | +22605-10 |         | 64 |    |
| 0   | +26322-   | 8   | 0         | +81368- | 9         | 0       | +25438-   | 9       | 0         | +10292-   | 9         | 0         | +44664-12 | 0         | +         | 0+      | 0  | 65 |
| 0   | +10710-10 | 0   | +49694-11 | 0       | +23126-11 | 0       | +23126-11 | 0       | +10334-11 | 0         | +16092-   | 3         | 0         | +97603-   | 4         |         | 66 |    |
| 0   | +29400-   | 5   | 0         | +       | 0+        | 0       | 0         | +52124- | 3         | 0         | +51830-   | 3         | 0         | +50120-   | 5         | +18438- | 5  | 67 |
| 0   | +59200-   | 4   | 0         | +35906- | 4         | 0       | +21778-   | 4       | 0         | +11809-   | 4         | 0         | +11849-   | 7         | 0         | +40575- | 8  | 68 |
| 0   | +67792-   | 6   | 0         | +24879- | 6         | 0       | +91243-   | 7       | 0         | +33238-   | 7         | 0         | +34845-10 | 0         | +16509-10 |         | 69 |    |
| 0   | +12543-   | 8   | 0         | +39213- | 9         | 0       | +15865-   | 9       | 0         | +76952-10 | 0         | +98095-   | 526R+     | 0+        | 0         |         | 70 |    |
| 0   | +76602-11 | 0   | +35648-11 | 0       | +15930-11 | 0       | +68849-12 |         |           |           |           |           |           |           |           |         | 71 |    |
| 3R+ | 0+        | 0   | 0         | +55733- | 527R+     | 0+      | 0         | 0       | +89798-   | 5         | 0         | +18218-   | 4         | 0         | +18333-   | 4       | 1  |    |
| 0   | +12925-   | 4   | 0         | +13581- | 4         | 0       | +46337-   | 525R+   | 0+        | 0         | 0         | +23715-   | 4         | 0         | +86597-   | 5       | 2  |    |
| 0   | +64154-   | 5   | 0         | +21888- | 524R+     | 0+      | 0         | 0       | +24091-   | 4         | 0         | +30969-   | 4         | 0         | +11202-   | 4       | 3  |    |
| 0   | +30304-   | 5   | 0         | +10339- | 523R+     | 0+      | 0         | 0       | +32534-   | 4         | 0         | +39620-   | 4         | 0         | +39407-   | 4       | 4  |    |
| 0   | +40905-   | 5   | 0         | +14315- | 5         | 0       | +48839-   | 622R+   | 0+        | 0         | 0         | +23070-   | 621R+     | 0+        | 0         |         | 5  |    |
| 0   | +14629-   | 4   | 0         | +52915- | 5         | 0       | +19322-   | 5       | 0         | +67618-   | 6         | 0         | +24995-   | 5         | 0         | +91273- | 6  | 6  |
| 0   | +53280-   | 4   | 0         | +53318- | 4         | 0       | +18614-   | 4       | 0         | +69101-   | 5         | 0         | +84683-   | 4         | 0         | +32237- | 4  | 7  |
| 0   | +31940-   | 6   | 0         | +10897- | 620R+     | 0+      | 0         | 0       | +93073-   | 4         | 0         | +19312-   | 6         | 0         | +65886-   | 7       | 8  |    |
| 0   | +11254-   | 4   | 0         | +41779- | 5         | 0       | +15112-   | 5       | 0         | +55185-   | 6         | 0         |           |           |           |         | 9  |    |

|      |         |    |   |         |    |      |         |    |      |         |    |   |         |    |      |         |    |    |
|------|---------|----|---|---------|----|------|---------|----|------|---------|----|---|---------|----|------|---------|----|----|
| 19R+ | 0+      | 0  | 0 | +14681- | 3  | 0    | +10867- | 3  | 0    | +31626- | 4  | 0 | +12039- | 4  | 0    | +42030- | 5  | 10 |
| 0    | +15603- | 5  | 0 | +56438- | 6  | 0    | +20609- | 6  | 0    | +72119- | 7  | 0 | +24605- | 7  | 18R+ | 0+      | 0  | 11 |
| 0    | +17390- | 3  | 0 | +12280- | 3  | 0    | +24248- | 4  | 0    | +70566- | 5  | 0 | +26862- | 5  | 0    | +93781- | 6  | 12 |
| 0    | +34814- | 6  | 0 | +12593- | 6  | 0    | +45984- | 7  | 0    | +16092- | 7  | 0 | +54903- | 8  | 17R+ | 0+      | 0  | 13 |
| 0    | +18827- | 3  | 0 | +14625- | 3  | 0    | +27400- | 4  | 0    | +54104- | 5  | 0 | +15745- | 5  | 0    | +59938- | 6  | 14 |
| 0    | +20925- | 6  | 0 | +77681- | 7  | 0    | +28099- | 7  | 0    | +10261- | 7  | 0 | +35907- | 8  | 0    | +12250- | 8  | 15 |
| 16R+ | 0+      | 0  | 0 | +19336- | 3  | 0    | +15690- | 3  | 0    | +32633- | 4  | 0 | +61137- | 5  | 0    | +12072- | 5  | 16 |
| 0    | +35133- | 6  | 0 | +13374- | 6  | 0    | +46691- | 7  | 0    | +17333- | 7  | 0 | +62697- | 8  | 0    | +22895- | 8  | 17 |
| 0    | +80118- | 9  | 0 | +27335- | 9  | 15R+ | 0+      | 0  | 0    | +19575- | 3  | 0 | +16206- | 3  | 0    | +35008- | 4  | 18 |
| 0    | +72815- | 5  | 0 | +13642- | 5  | 0    | +26937- | 6  | 0    | +78392- | 7  | 0 | +29842- | 7  | 0    | +10418- | 7  | 19 |
| 0    | +38675- | 8  | 0 | +13990- | 8  | 0    | +51085- | 9  | 0    | +17877- | 9  | 0 | +60992- | 10 | 14R+ | 0+      | 0  | 20 |
| 0    | +19646- | 3  | 0 | +16359- | 3  | 0    | +36161- | 4  | 0    | +78115- | 5  | 0 | +16247- | 5  | 0    | +30439- | 6  | 21 |
| 0    | +60104- | 7  | 0 | +17491- | 7  | 0    | +66585- | 8  | 0    | +23246- | 8  | 0 | +86295- | 9  | 0    | +31215- | 9  | 22 |
| 0    | +11398- | 9  | 0 | +39888- | 10 | 0    | +13609- | 10 | 13R+ | 0+      | 0  | 0 | +19696- | 3  | 0    | +16407- | 3  | 23 |
| 0    | +36502- | 4  | 0 | +80685- | 5  | 0    | +17430- | 5  | 0    | +36252- | 6  | 0 | +67917- | 7  | 0    | +13411- | 7  | 24 |
| 0    | +39029- | 8  | 0 | +14857- | 8  | 0    | +51869- | 9  | 0    | +19255- | 9  | 0 | +69650- | 10 | 0    | +28433- | 10 | 25 |
| 0    | +89003- | 11 | 0 | +30366- | 11 | 12R+ | 0+      | 0  | 0    | +19717- | 3  | 0 | +16447- | 3  | 0    | +36610- | 4  | 26 |
| 0    | +81446- | 5  | 0 | +18003- | 5  | 0    | +38891- | 6  | 0    | +80890- | 7  | 0 | +15155- | 7  | 0    | +29924- | 8  | 27 |
| 0    | +87085- | 9  | 0 | +33151- | 9  | 0    | +11574- | 9  | 0    | +42964- | 10 | 0 | +15541- | 10 | 0    | +56751- | 11 | 28 |
| 0    | +19859- | 11 | 0 | +67757- | 12 | 11R+ | 0+      | 0  | 0    | +19717- | 3  | 0 | +16455- | 3  | 0    | +36699- | 4  | 29 |
| 0    | +81688- | 5  | 0 | +18173- | 5  | 0    | +40171- | 6  | 0    | +86777- | 7  | 0 | +18049- | 7  | 0    | +33814- | 8  | 30 |
| 0    | +66770- | 9  | 0 | +19431- | 9  | 0    | +73970- | 10 | 0    | +25824- | 10 | 0 | +95867- | 11 | 0    | +34677- | 11 | 31 |
| 0    | +12663- | 11 | 0 | +44312- | 12 | 0    | +15119- | 12 | 10R+ | 0+      | 0  | 0 | +16347- | 3  | 0    | +14305- | 3  | 32 |
| 0    | +31919- | 4  | 0 | +71185- | 5  | 0    | +15845- | 5  | 0    | +35251- | 6  | 0 | +77920- | 7  | 0    | +16832- | 7  | 33 |
| 0    | +35010- | 8  | 0 | +65590- | 9  | 0    | +12951- | 9  | 0    | +37691- | 10 | 0 | +14348- | 10 | 0    | +50092- | 11 | 34 |
| 0    | +18595- | 11 | 0 | +67263- | 12 | 0    | +24562- | 12 | 0    | +85953- | 13 | 0 | +29326- | 13 | 9R+  | 0+      | 0  | 35 |
| 0    | +12126- | 3  | 0 | +12954- | 3  | 0    | +36284- | 4  | 0    | +80960- | 5  | 0 | +18056- | 5  | 0    | +40190- | 6  | 36 |
| 0    | +89410- | 7  | 0 | +19764- | 7  | 0    | +42694- | 8  | 0    | +88800- | 9  | 0 | +16636- | 9  | 0    | +32850- | 10 | 37 |
| 0    | +95601- | 11 | 0 | +36393- | 11 | 0    | +12705- | 11 | 0    | +47166- | 12 | 0 | +17061- | 12 | 0    | +62300- | 13 | 38 |
| 0    | +21801- | 13 | 0 | +74383- | 14 | 8R+  | 0+      | 0  | 0    | +12126- | 3  | 0 | +15181- | 3  | 0    | +61191- | 4  | 39 |
| 0    | +17139- | 4  | 0 | +38243- | 5  | 0    | +85289- | 6  | 0    | +18984- | 6  | 0 | +42234- | 7  | 0    | +93358- | 8  | 40 |
| 0    | +20167- | 8  | 0 | +41946- | 9  | 0    | +78585- | 10 | 0    | +15517- | 10 | 0 | +45159- | 11 | 0    | +17191- | 11 | 41 |
| 0    | +60016- | 12 | 0 | +22280- | 12 | 0    | +80590- | 13 | 0    | +29428- | 13 | 0 | +10298- | 13 | 0    | +35136- | 14 | 42 |
| 7R+  | 0+      | 0  | 0 | +12126- | 3  | 0    | +15181- | 3  | 0    | +71711- | 4  | 0 | +28905- | 4  | 0    | +80959- | 5  | 43 |
| 0    | +18065- | 5  | 0 | +40287- | 6  | 0    | +89676- | 7  | 0    | +19950- | 7  | 0 | +44099- | 8  | 0    | +95263- | 9  | 44 |
| 0    | +19814- | 9  | 0 | +37121- | 10 | 0    | +73299- | 11 | 0    | +21332- | 11 | 0 | +81204- | 12 | 0    | +28349- | 12 | 45 |

|      |           |   |           |      |           |      |           |   |           |      |           |
|------|-----------|---|-----------|------|-----------|------|-----------|---|-----------|------|-----------|
| 0    | +10524-12 | 0 | +38068-13 | 0    | +13901-13 | 0    | +48645-14 | 0 | +16597-14 | 6R+  | 0+ 0      |
| 0    | +12126-3  | 0 | +15181-3  | 0    | +71711-4  | 0    | +33874-4  | 0 | +13654-4  | 0    | +38242-5  |
| 0    | +85331-6  | 0 | +19031-6  | 0    | +42360-7  | 0    | +94238-8  | 0 | +20831-8  | 0    | +44999-9  |
| 0    | +93594-10 | 0 | +17535-10 | 0    | +34624-11 | 0    | +10076-11 | 0 | +38358-12 | 0    | +13392-12 |
| 0    | +49712-13 | 0 | +17982-13 | 0    | +65663-14 | 0    | +22978-14 | 0 | +78402-15 | 5R+  | 0+ 0      |
| 0    | +12126-3  | 0 | +15181-3  | 0    | +71711-4  | 0    | +33874-4  | 0 | +16001-4  | 0    | +64494-5  |
| 0    | +18065-5  | 0 | +40308-6  | 0    | +89894-7  | 0    | +20010-7  | 0 | +44515-8  | 0    | +98399-9  |
| 0    | +21256-9  | 0 | +44211-10 | 0    | +82828-11 | 0    | +16355-11 | 0 | +47597-12 | 0    | +18119-12 |
| 0    | +63256-13 | 0 | +23483-13 | 0    | +84942-14 | 0    | +31017-14 | 0 | +10854-14 | 0    | +37032-15 |
| 5R+  | 0+ 0      | 0 | +28772-3  | 0    | +13591-3  | 0    | +64200-4  | 0 | +30326-4  | 0    | +14325-4  |
| 0    | +57740-5  | 0 | +16172-5  | 0    | +36086-6  | 0    | +80478-7  | 0 | +17914-7  | 0    | +39852-8  |
| 0    | +88092-9  | 0 | +19030-9  | 0    | +39580-10 | 0    | +74153-11 | 0 | +14642-11 | 0    | +42612-12 |
| 0    | +16221-12 | 0 | +56631-13 | 0    | +21023-13 | 0    | +76044-14 | 0 | +27768-14 | 0    | +97173-15 |
| 0    | +33153-15 |   |           |      |           |      |           |   |           |      |           |
| 3R+  | 0+ 0      | 0 | +80377-5  | 27R+ | 0+ 0      | 0    | +13015-4  | 0 | +10485-4  | 26R+ | 0+ 0      |
| 0    | +18651-4  | 0 | +13935-4  | 4    | +14890-5  | 25R+ | 0+ 0      | 0 | +26068-4  | 0    | +18507-4  |
| 0    | +18035-5  | 0 | -88849-6  | 24R+ | 0+ 0      | 0    | +34391-4  | 0 | +23417-4  | 0    | +22977-5  |
| 0    | -13520-5  | 0 | -11980-5  | 23R+ | 0+ 0      | 0    | +46335-4  | 0 | +30497-4  | 0    | +27360-5  |
| 0    | -18904-5  | 0 | -17199-5  | 5    | -96911-6  | 22R+ | 0+ 0      | 0 | +56855-4  | 0    | +38072-4  |
| 0    | +35348-5  | 0 | -25590-5  | 5    | -23547-5  | 5    | -13742-5  | 0 | -67699-5  | 21R+ | 0+ 0      |
| 0    | +76053-4  | 0 | +53125-4  | 4    | +41684-5  | 5    | -33605-5  | 0 | -31040-5  | 0    | -18726-5  |
| 0    | -95525-6  | 0 | -44343-6  | 20R+ | 0+ 0      | 0    | +12411-3  | 0 | +71403-4  | 0    | +40744-5  |
| 0    | -71466-5  | 0 | -57983-5  | 5    | -33888-5  | 5    | -17706-5  | 0 | -84476-6  | 0    | -37894-6  |
| 19R+ | 0+ 0      | 0 | +18414-3  | 0    | +66220-4  | 0    | -11668-4  | 0 | -13249-4  | 0    | -82324-5  |
| 0    | -44995-5  | 0 | -22612-5  | 5    | -11004-5  | 5    | -50501-6  | 0 | -22171-6  | 18R+ | 0+ 0      |
| 0    | +21829-3  | 0 | +61604-4  | 4    | -21153-4  | 0    | -13763-4  | 0 | -77030-5  | 0    | -37902-5  |
| 0    | -18768-5  | 0 | -89432-6  | 6    | -42269-6  | 0    | -19068-6  | 0 | -82882-7  | 17R+ | 0+ 0      |
| 0    | +23607-3  | 0 | +73682-4  | 0    | -27100-4  | 0    | -13941-4  | 0 | -63447-5  | 0    | -32166-5  |
| 0    | -14974-5  | 0 | -72044-6  | 0    | -33745-6  | 0    | -15792-6  | 0 | -70812-7  | 0    | -30669-7  |
| 16R+ | 0+ 0      | 0 | +24260-3  | 0    | +78428-4  | 0    | -32201-4  | 0 | -16704-4  | 0    | -59624-5  |
| 0    | -25076-5  | 0 | -12351-5  | 5    | -56481-6  | 0    | -26909-6  | 0 | -12529-6  | 0    | -58422-7  |
| 0    | -26140-7  | 0 | -11307-7  | 15R+ | 0+ 0      | 0    | +24551-3  | 0 | +81431-4  | 0    | -34690-4  |
| 0    | -19872-4  | 0 | -70565-5  | 5    | -23062-5  | 0    | -94596-6  | 0 | -46139-6  | 0    | -20967-6  |
| 0    | -99542-7  | 0 | -46245-7  | 0    | -21537-7  | 0    | -96284-8  | 0 | -41628-8  | 14R+ | 0+ 0      |
| 0    | +24638-3  | 0 | +81994-4  | 0    | -35733-4  | 0    | -21361-4  | 0 | -83968-5  | 0    | -27193-5  |
| 0    | -86369-6  | 0 | -35118-6  | 0    | -17069-6  | 0    | -77389-7  | 0 | -36694-7  | 0    | -17034-7  |

46  
47  
48  
49  
50  
51  
52  
53  
54  
55  
56  
57  
58  
59

59

|      |           |   |           |           |         |         |         |         |         |           |         |         |         |           |           |           |
|------|-----------|---|-----------|-----------|---------|---------|---------|---------|---------|-----------|---------|---------|---------|-----------|-----------|-----------|
| 0    | -17212-11 | 0 | +90081-   | 527R+     | 0+      | 0       | 0       | +14645- | 4       | 0         | +56667- | 526R+   | 0+      | 0         |           |           |
| 3R+  | 0+        | 0 | +62949-   | 5         | 0       | -47577- | 525R+   | 0+      | 0       | 0         | +28693- | 4       | 0       | +77415- 5 |           |           |
| 0    | +20828-   | 4 | 0         | -43774-   | 524R+   | 0+      | 0       | +37699- | 4       | 0         | +87661- | 5       | 0       | -97077- 5 |           |           |
| 0    | -70313-   | 5 | 0         | -26780-   | 523R+   | 0+      | 0       | +50581- | 4       | 0         | +11283- | 4       | 0       | -12915- 4 |           |           |
| 0    | -61878-   | 5 | 0         | -37442-   | 5       | 0       | -14398- | 522R+   | 0+      | 0         | +62900- | 4       | 0       | +12495- 4 |           |           |
| 0    | -84146-   | 5 | 0         | -10988-   | 4       | 0       | -50718- | 5       | 0       | -20039-   | 5       | 0       | -73023- | 621R+     | 0+        | 0         |
| 0    | -16913-   | 4 | 0         | +20857-   | 4       | 0       | -22055- | 4       | 0       | -14362-   | 4       | 0       | -65901- | 5         | 0         | -27101- 5 |
| 0    | +83343-   | 4 | 0         | -35929-   | 620R+   | 0+      | 0       | +12104- | 3       | 0         | +46161- | 5       | 0       | -42294- 4 |           |           |
| 0    | -10140-   | 5 | 0         | -11283-   | 4       | 0       | -45556- | 5       | 0       | -17667-   | 5       | 0       | -64058- | 6         | 0         | -22308- 6 |
| 0    | -24739-   | 4 | 0         | +16077-   | 3       | 0       | -42049- | 4       | 0       | -60643-   | 4       | 0       | -30409- | 4         | 0         | -12275- 4 |
| 19R+ | 0+        | 0 | -18533-   | 5         | 0       | -69392- | 6       | 0       | -24655- | 6         | 0       | -84869- | 718R+   | 0+        | 0         | 0         |
| 0    | -49056-   | 5 | 0         | -69544-   | 4       | 0       | -57097- | 4       | 0       | -20590-   | 4       | 0       | -84393- | 5         | 0         | -30824- 5 |
| 0    | +19091-   | 3 | 0         | -43074-   | 6       | 0       | -15870- | 6       | 0       | -55841-   | 7       | 0       | -19113- | 717R+     | 0+        | 0         |
| 0    | -11729-   | 5 | 0         | -82304-   | 4       | 0       | -66329- | 4       | 0       | -16657-   | 4       | 0       | -51737- | 5         | 0         | -20188- 5 |
| 0    | +20602-   | 3 | 0         | -26814-   | 6       | 0       | -97524- | 7       | 0       | -35727-   | 7       | 0       | -12528- | 7         | 0         | -42793- 8 |
| 0    | -71597-   | 6 | 0         | +21194-   | 3       | 0       | -89415- | 4       | 0       | -78955-   | 4       | 0       | -18971- | 4         | 0         | -40382- 5 |
| 16R+ | 0+        | 0 | -46160-   | 6         | 0       | -16207- | 6       | 0       | -60358- | 7         | 0       | -21876- | 7       | 0         | -79979- 8 |           |
| 0    | -12020-   | 5 | 0         | -95602-   | 915R+   | 0+      | 0       | +21435- | 3       | 0         | -91566- | 4       | 0       | -84793- 4 |           |           |
| 0    | -28009-   | 8 | 0         | -45753-   | 5       | 0       | -92742- | 6       | 0       | -27210-   | 6       | 0       | -10391- | 6         | 0         | -36353- 7 |
| 0    | -22591-   | 4 | 0         | -48908-   | 8       | 0       | -17867- | 8       | 0       | -62542-   | 9       | 0       | -21341- | 914R+     | 0+        | 0         |
| 0    | -13511-   | 7 | 0         | -92798-   | 4       | 0       | -87518- | 4       | 0       | -24242-   | 4       | 0       | -54488- | 5         | 0         | -10490- 5 |
| 0    | +21506-   | 3 | 0         | -61034-   | 7       | 0       | -23261- | 7       | 0       | -81270-   | 8       | 0       | -30183- | 8         | 0         | -10921- 8 |
| 0    | -20910-   | 6 | 0         | -13959-   | 9       | 0       | -47627- | 1013R+  | 0+      | 0         | 0       | +21560- | 3       | 0         | -93151- 4 |           |
| 0    | -39884-   | 9 | 0         | -25035-   | 4       | 0       | -58461- | 5       | 0       | -12493-   | 5       | 0       | -23637- | 6         | 0         | -46835- 7 |
| 0    | -88374-   | 4 | 0         | -51964-   | 8       | 0       | -18147- | 8       | 0       | -67375-   | 9       | 0       | -24374- | 9         | 0         | -89008-10 |
| 0    | -13645-   | 7 | 0         | -10628-   | 1012R+  | 0+      | 0       | +21579- | 3       | 0         | -93395- | 4       | 0       | -88643- 4 |           |           |
| 0    | -31149-10 | 0 | -60381-   | 5         | 0       | -13403- | 5       | 0       | -28151- | 6         | 0       | -52930- | 7       | 0         | -10465- 7 |           |
| 0    | -25273-   | 4 | 0         | -11600-   | 8       | 0       | -40501- | 9       | 0       | -15036-   | 9       | 0       | -54391- | 10        | 0         | -19862-10 |
| 0    | -30467-   | 8 | 0         | -23715-   | 1111R+  | 0+      | 0       | +21579- | 3       | 0         | -93507- | 4       | 0       | -88860- 4 |           |           |
| 0    | -69506-11 | 0 | -60952-   | 5         | 0       | -13844- | 5       | 0       | -30201- | 6         | 0       | -63040- | 7       | 0         | -11826- 7 |           |
| 0    | -25349-   | 4 | 0         | -68000-   | 9       | 0       | -25887- | 9       | 0       | -90379-10 | 0       | -33552- | 10      | 0         | -12137-10 |           |
| 0    | -23362-   | 8 | 0         | -15509-11 | 0       | -52915- | 1210R+  | 0+      | 0       | 0         | +21295- | 3       | 0       | -55700- 4 |           |           |
| 0    | -44319-11 | 0 | -21918-   | 4         | 0       | -53004- | 5       | 0       | -12137- | 5         | 0       | -27109- | 6       | 0         | -58784- 7 |           |
| 0    | -75190-   | 4 | 0         | -22949-   | 8       | 0       | -45324- | 9       | 0       | -13191-   | 9       | 0       | -50216- | 10        | 0         | -17532-10 |
| 0    | -12243-   | 7 | 0         | -23542-11 | 0       | -85966- | 12      | 0       | -30083- | 12        | 0       | -10264- | 12      | 9R+       | 0+        | 0         |
| 0    | -65083-11 | 0 | -23542-11 | 0         | -85966- | 12      | 0       | -30083- | 12      | 0         | -10264- | 12      | 9R+     | 0+        | 0         | 0         |

|     |         |    |   |         |       |     |         |        |         |         |    |         |         |    |         |         |    |    |
|-----|---------|----|---|---------|-------|-----|---------|--------|---------|---------|----|---------|---------|----|---------|---------|----|----|
| 0   | -79290- | 8  | 0 | -35438- | 8     | 0   | -15318- | 813R+  | 0+      | 0       | 0  | +24700- | 3       | 0  | +82194- | 4       | 23 |    |
| 0   | -36118- | 4  | 0 | -22036- | 4     | 0   | -90222- | 5      | 0       | -32360- | 5  | 0       | -10171- | 5  | 0       | -31980- | 6  | 24 |
| 0   | -12962- | 6  | 0 | -62920- | 7     | 0   | -28505- | 7      | 0       | -13509- | 7  | 0       | -62691- | 8  | 0       | -29177- | 8  | 25 |
| 0   | -13039- | 8  | 0 | -56360- | 912R+ | 0+  | 0       | 0      | +24724- | 3       | 0  | +82386- | 4       | 0  | -36236- | 4       | 26 |    |
| 0   | -22257- | 4  | 0 | -93096- | 5     | 0   | -34766- | 5      | 0       | -12104- | 5  | 0       | -37641- | 6  | 0       | -11793- | 6  | 27 |
| 0   | -47743- | 7  | 0 | -23164- | 7     | 0   | -10491- | 7      | 0       | -49711- | 8  | 0       | -23067- | 8  | 0       | -10735- | 8  | 28 |
| 0   | -47971- | 9  | 0 | -20734- | 911R+ | 0+  | 0       | 0      | +24724- | 3       | 0  | +82389- | 4       | 0  | -36326- | 4       | 29 |    |
| 0   | -22327- | 4  | 0 | -94020- | 5     | 0   | -35876- | 5      | 0       | -13003- | 5  | 0       | -44796- | 6  | 0       | -13878- | 6  | 30 |
| 0   | -43421- | 7  | 0 | -17572- | 7     | 0   | -85241- | 8      | 0       | -38600- | 8  | 0       | -18289- | 8  | 0       | -84863- | 9  | 31 |
| 0   | -39492- | 9  | 0 | -17648- | 9     | 0   | -76279- | 1010R+ | 0+      | 0       | 0  | +21811- | 3       | 0  | +87048- | 4       | 32 |    |
| 0   | -27870- | 4  | 0 | -18347- | 4     | 0   | -78269- | 5      | 0       | -30181- | 5  | 0       | -11192- | 5  | 0       | -40158- | 6  | 33 |
| 0   | -13785- | 6  | 0 | -42649- | 7     | 0   | -13337- | 7      | 0       | -53965- | 8  | 0       | -26177- | 8  | 0       | -11854- | 8  | 34 |
| 0   | -56163- | 9  | 0 | -26059- | 9     | 0   | -12127- | 9      | 0       | -54192- | 10 | 0       | -23423- | 10 | 9R+     | 0+      | 0  | 35 |
| 0   | +17318- | 3  | 0 | +10954- | 3     | 0   | -13302- | 4      | 0       | -15767- | 4  | 0       | -72679- | 5  | 0       | -28657- | 5  | 36 |
| 0   | -10778- | 5  | 0 | -39622- | 6     | 0   | -14172- | 6      | 0       | -48590- | 7  | 0       | -15027- | 7  | 0       | -46987- | 8  | 37 |
| 0   | -19011- | 8  | 0 | -92214- | 9     | 0   | -41756- | 9      | 0       | -19784- | 9  | 0       | -91797- | 10 | 0       | -42718- | 10 | 38 |
| 0   | -19089- | 10 | 0 | -82509- | 11    | 8R+ | 0+      | 0      | 0       | +17318- | 3  | 0       | +14812- | 3  | 0       | +65246- | 5  | 39 |
| 0   | -19227- | 4  | 0 | -11074- | 4     | 0   | -46125- | 5      | 0       | -17658- | 5  | 0       | -65745- | 6  | 0       | -24082- | 6  | 40 |
| 0   | -86020- | 7  | 0 | -29479- | 7     | 0   | -91152- | 8      | 0       | -28500- | 8  | 0       | -11531- | 8  | 0       | -55931- | 9  | 41 |
| 0   | -25326- | 9  | 0 | -12000- | 9     | 0   | -55678- | 10     | 0       | -25910- | 10 | 0       | -11578- | 10 | 0       | -50044- | 11 | 42 |
| 7R+ | 0+      | 0  | 0 | +17318- | 3     | 0   | +14812- | 3      | 0       | +16712- | 4  | 0       | -18084- | 4  | 0       | -15767- | 4  | 43 |
| 0   | -72721- | 5  | 0 | -28728- | 5     | 0   | -10811- | 5      | 0       | -40013- | 6  | 0       | -14625- | 6  | 0       | -52198- | 7  | 44 |
| 0   | -17883- | 7  | 0 | -55290- | 8     | 0   | -17286- | 8      | 0       | -69938- | 9  | 0       | -33925- | 9  | 0       | -15361- | 9  | 45 |
| 0   | -72782- | 10 | 0 | -33770- | 10    | 0   | -15715- | 10     | 0       | -70227- | 11 | 0       | -30354- | 11 | 6R+     | 0+      | 0  | 46 |
| 0   | +17318- | 3  | 0 | +14812- | 3     | 0   | +16712- | 4      | 0       | -16765- | 4  | 0       | -19077- | 4  | 0       | -11074- | 4  | 47 |
| 0   | -46152- | 5  | 0 | -17701- | 5     | 0   | -65947- | 6      | 0       | -24320- | 6  | 0       | -88771- | 7  | 0       | -31669- | 7  | 48 |
| 0   | -10848- | 7  | 0 | -33536- | 8     | 0   | -10485- | 8      | 0       | -42420- | 9  | 0       | -20576- | 9  | 0       | -93171- | 10 | 49 |
| 0   | -44144- | 10 | 0 | -20483- | 10    | 0   | -95319- | 11     | 0       | -42595- | 11 | 0       | -18411- | 11 | 5R+     | 0+      | 0  | 50 |
| 0   | +17318- | 3  | 0 | +14812- | 3     | 0   | +16712- | 4      | 0       | -16765- | 4  | 0       | -20065- | 4  | 0       | -14553- | 4  | 51 |
| 0   | -72721- | 5  | 0 | -28744- | 5     | 0   | -10838- | 5      | 0       | -40136- | 6  | 0       | -14769- | 6  | 0       | -53867- | 7  | 52 |
| 0   | -19211- | 7  | 0 | -65799- | 8     | 0   | -20342- | 8      | 0       | -63595- | 9  | 0       | -25729- | 9  | 0       | -12480- | 9  | 53 |
| 0   | -56512- | 10 | 0 | -26775- | 10    | 0   | -12423- | 10     | 0       | -57814- | 11 | 0       | -25835- | 11 | 0       | -11166- | 11 | 54 |
| 5R+ | 0+      | 0  | 0 | +82430- | 4     | 0   | -65685- | 4      | 0       | -82397- | 4  | 0       | -65633- | 4  | 0       | -45568- | 4  | 55 |
| 0   | -26846- | 4  | 0 | -12032- | 4     | 0   | -45421- | 5      | 0       | -16857- | 5  | 0       | -62073- | 6  | 0       | -22794- | 6  | 56 |
| 0   | -83072- | 7  | 0 | -29619- | 7     | 0   | -10143- | 7      | 0       | -31357- | 8  | 0       | -98032- | 9  | 0       | -39661- | 9  | 57 |
| 0   | -19238- | 9  | 0 | -87112- | 10    | 0   | -41274- | 10     | 0       | -19150- | 10 | 0       | -89120- | 11 | 0       | -39824- | 11 | 58 |

|      |         |    |   |         |       |     |         |       |         |         |    |         |         |       |         |         |    |
|------|---------|----|---|---------|-------|-----|---------|-------|---------|---------|----|---------|---------|-------|---------|---------|----|
| 0    | +18997- | 3  | 0 | +77747- | 5     | 0   | -69486- | 4     | 0       | -23616- | 4  | 0       | -59321- | 5     | 0       | -13749- | 5  |
| 0    | -31034- | 6  | 0 | -68962- | 7     | 0   | -14926- | 7     | 0       | -31067- | 8  | 0       | -58218- | 9     | 0       | -11497- | 9  |
| 0    | -33459- | 10 | 0 | -12737- | 10    | 0   | -44468- | 11    | 0       | -16508- | 11 | 0       | -59713- | 12    | 0       | -21805- | 12 |
| 0    | -76305- | 13 | 0 | -26034- | 13    | 8R+ | 0+      | 0     | 0       | +18997- | 3  | 0       | +51624- | 4     | 0       | -82042- | 4  |
| 0    | -43511- | 4  | 0 | -12033- | 4     | 0   | -28741- | 5     | 0       | -65537- | 6  | 0       | -14708- | 6     | 0       | -32614- | 7  |
| 0    | -70537- | 8  | 0 | -14677- | 8     | 0   | -27502- | 9     | 0       | -54309- | 10 | 0       | -15805- | 10    | 0       | -60167- | 11 |
| 0    | -21005- | 11 | 0 | -77978- | 12    | 0   | -28207- | 12    | 0       | -10300- | 12 | 0       | -36044- | 13    | 0       | -12298- | 13 |
| 7R+  | 0+      | 0  | 0 | +18997- | 3     | 0   | +51624- | 4     | 0       | -83966- | 4  | 0       | -63311- | 4     | 0       | -23616- | 4  |
| 0    | -59351- | 5  | 0 | -13783- | 5     | 0   | -31126- | 6     | 0       | -69612- | 7  | 0       | -15417- | 7     | 0       | -33329- | 8  |
| 0    | -69338- | 9  | 0 | -12991- | 9     | 0   | -25654- | 10    | 0       | -74660- | 11 | 0       | -28421- | 11    | 0       | -99224- | 12 |
| 0    | -36834- | 12 | 0 | -13324- | 12    | 0   | -48653- | 13    | 0       | -17026- | 13 | 0       | -58090- | 14    | 6R+     | 0+      | 0  |
| 0    | +18997- | 3  | 0 | +51624- | 4     | 0   | -83966- | 4     | 0       | -70706- | 4  | 0       | -36942- | 4     | 0       | -12033- | 4  |
| 0    | -28756- | 5  | 0 | -65696- | 6     | 0   | -14751- | 6     | 0       | -32922- | 7  | 0       | -72859- | 8     | 0       | -15746- | 8  |
| 0    | -32755- | 9  | 0 | -61369- | 10    | 0   | -12118- | 10    | 0       | -35267- | 11 | 0       | -13425- | 11    | 0       | -46870- | 12 |
| 0    | -17399- | 12 | 0 | -62937- | 13    | 0   | -22982- | 13    | 0       | -80425- | 14 | 0       | -27441- | 14    | 5R+     | 0+      | 0  |
| 0    | +18997- | 3  | 0 | +51624- | 4     | 0   | -83966- | 4     | 0       | -70706- | 4  | 0       | -42293- | 4     | 0       | -19466- | 4  |
| 0    | -59351- | 5  | 0 | -13790- | 5     | 0   | -31202- | 6     | 0       | -69819- | 7  | 0       | -15563- | 7     | 0       | -34426- | 8  |
| 0    | -74385- | 9  | 0 | -15473- | 9     | 0   | -28989- | 10    | 0       | -57242- | 11 | 0       | -16659- | 11    | 0       | -63416- | 12 |
| 0    | -22140- | 12 | 0 | -82189- | 13    | 0   | -29730- | 13    | 0       | -10856- | 13 | 0       | -37990- | 14    | 0       | -12961- | 14 |
| 5R+  | 0+      | 0  | 0 | -18997- | 3     | 0   | -24159- | 3     | 0       | -15763- | 3  | 0       | -86925- | 4     | 0       | -44632- | 4  |
| 0    | -18961- | 4  | 0 | -55047- | 5     | 0   | -12502- | 5     | 0       | -28063- | 6  | 0       | -62611- | 7     | 0       | -13941- | 7  |
| 0    | -30826- | 8  | 0 | -66600- | 9     | 0   | -13853- | 9     | 0       | -25953- | 10 | 0       | -51247- | 11    | 0       | -14914- | 11 |
| 0    | -56774- | 12 | 0 | -19821- | 12    | 0   | -73580- | 13    | 0       | -26615- | 13 | 0       | -97188- | 14    | 0       | -34010- | 14 |
| 0    | -11604- | 14 |   |         |       |     |         |       |         |         |    |         |         |       |         |         |    |
| 3R+  | 0+      | 0  | 0 | +85119- | 527R+ | 0+  | 0       | 0     | +13795- | 4       | 0  | -21569- | 526R+   | 0+    | 0       |         |    |
| 0    | +19370- | 4  | 0 | -53840- | 5     | 0   | -86380- | 525R+ | 0+      | 0       | 0  | +26057- | 4       | 0     | -83074- | 5       |    |
| 0    | -12141- | 4  | 0 | -37025- | 524R+ | 0+  | 0       | 0     | +33997- | 4       | 0  | -12334- | 4       | 0     | -16437- | 4       |    |
| 0    | -50137- | 5  | 0 | -73572- | 623R+ | 0+  | 0       | 0     | +45273- | 4       | 0  | -16221- | 4       | 0     | -21301- | 4       |    |
| 0    | -66977- | 5  | 0 | -92332- | 6     | 0   | +32000- | 622R+ | 0+      | 0       | 0  | +57626- | 4       | 0     | -23306- | 4       |    |
| 0    | -27792- | 4  | 0 | -85337- | 5     | 0   | -11933- | 5     | 0       | +49863- | 6  | 0       | +52299- | 621R+ | 0+      | 0       |    |
| 0    | +75089- | 4  | 0 | -26251- | 4     | 0   | -35514- | 4     | 0       | -11116- | 4  | 0       | -14495- | 5     | 0       | +70337- | 6  |
| 0    | +75424- | 6  | 0 | +44871- | 620R+ | 0+  | 0       | 0     | +89536- | 4       | 0  | -72241- | 4       | 0     | -60425- | 4       |    |
| 0    | -15965- | 4  | 0 | -14110- | 5     | 0   | +16549- | 5     | 0       | +15002- | 5  | 0       | +88746- | 6     | 0       | +44194- | 6  |
| 19R+ | 0+      | 0  | 0 | +96061- | 4     | 0   | -12742- | 3     | 0       | -52000- | 4  | 0       | -93075- | 5     | 0       | +25801- | 5  |
| 0    | +33919- | 5  | 0 | +22611- | 5     | 0   | +12528- | 5     | 0       | +61698- | 6  | 0       | +28168- | 618R+ | 0+      | 0       |    |
| 0    | +11452- | 3  | 0 | -15385- | 3     | 0   | -26079- | 4     | 0       | +42323- | 5  | 0       | +57670- | 5     | 0       | +38093- | 5  |

|      |         |    |   |         |       |     |         |       |    |         |    |   |         |       |      |         |    |
|------|---------|----|---|---------|-------|-----|---------|-------|----|---------|----|---|---------|-------|------|---------|----|
| 0    | +21435- | 5  | 0 | +10955- | 5     | 0   | +53831- | 6     | 0  | +24852- | 6  | 0 | +10948- | 6     | 17R+ | 0+      | 0  |
| 0    | +12297- | 3  | 0 | -18300- | 3     | 0   | -24600- | 4     | 0  | +89629- | 5  | 0 | +63658- | 5     | 0    | +36681- | 5  |
| 0    | +18370- | 5  | 0 | +91841- | 6     | 0   | +44020- | 6     | 0  | +20878- | 6  | 0 | +94384- | 7     | 0    | +41076- | 7  |
| 16R+ | 0+      | 0  | 0 | +12685- | 3     | 0   | -19707- | 3     | 0  | -29414- | 4  | 0 | +11700- | 4     | 0    | +65924- | 5  |
| 0    | +30747- | 5  | 0 | +15738- | 5     | 0   | +73714- | 6     | 0  | +35588- | 6  | 0 | +16705- | 6     | 0    | +78272- | 7  |
| 0    | +35125- | 7  | 0 | +15220- | 715R+ | 0+  | 0       | 0     | 0  | +12808- | 3  | 0 | -20297- | 3     | 0    | -31343- | 4  |
| 0    | +13898- | 4  | 0 | +79299- | 5     | 0   | +29102- | 5     | 0  | +12344- | 5  | 0 | +61009- | 6     | 0    | +27961- | 6  |
| 0    | +13338- | 6  | 0 | +62147- | 7     | 0   | +28994- | 7     | 0  | +12976- | 7  | 0 | +56137- | 814R+ | 0+   | 0       | 0  |
| 0    | +12845- | 3  | 0 | -20512- | 3     | 0   | -32515- | 4     | 0  | +14980- | 4  | 0 | +94332- | 5     | 0    | +34486- | 5  |
| 0    | +11382- | 5  | 0 | +46828- | 6     | 0   | +22869- | 6     | 0  | +10401- | 6  | 0 | +49401- | 7     | 0    | +22957- | 7  |
| 0    | +10693- | 7  | 0 | +47811- | 8     | 0   | +20672- | 813R+ | 0+ | 0       | 0  | 0 | +12877- | 3     | 0    | -20577- | 3  |
| 0    | -32751- | 4  | 0 | +15425- | 4     | 0   | +10141- | 4     | 0  | +41035- | 5  | 0 | +13426- | 5     | 0    | +42796- | 6  |
| 0    | +17420- | 6  | 0 | +84707- | 7     | 0   | +38418- | 7     | 0  | +18219- | 7  | 0 | +84581- | 8     | 0    | +39374- | 8  |
| 0    | +17599- | 8  | 0 | +76074- | 912R+ | 0+  | 0       | 0     | 0  | +12883- | 3  | 0 | -20629- | 3     | 0    | -32832- | 4  |
| 0    | +15594- | 4  | 0 | +10461- | 4     | 0   | +44094- | 5     | 0  | +15977- | 5  | 0 | +50403- | 6     | 0    | +15869- | 6  |
| 0    | +64346- | 7  | 0 | +31240- | 7     | 0   | +14154- | 7     | 0  | +67084- | 8  | 0 | +31133- | 8     | 0    | +14490- | 8  |
| 0    | +64755- | 9  | 0 | +27990- | 911R+ | 0+  | 0       | 0     | 0  | +12883- | 3  | 0 | -20643- | 3     | 0    | -32909- | 4  |
| 0    | +15646- | 4  | 0 | +10566- | 4     | 0   | +45497- | 5     | 0  | +17165- | 5  | 0 | +59982- | 6     | 0    | +18679- | 6  |
| 0    | +58549- | 7  | 0 | +23707- | 7     | 0   | +11503- | 7     | 0  | +52099- | 8  | 0 | +24687- | 8     | 0    | +11455- | 8  |
| 0    | +53312- | 9  | 0 | +23824- | 9     | 0   | +10297- | 910R+ | 0+ | 0       | 0  | 0 | +15785- | 3     | 0    | -16831- | 3  |
| 0    | -34309- | 4  | 0 | +11800- | 4     | 0   | +86546- | 5     | 0  | +38085- | 5  | 0 | +14749- | 5     | 0    | +53739- | 6  |
| 0    | +18549- | 6  | 0 | +57507- | 7     | 0   | +17997- | 7     | 0  | +72836- | 8  | 0 | +35334- | 8     | 0    | +16001- | 8  |
| 0    | +75816- | 9  | 0 | +35179- | 9     | 0   | +16371- | 9     | 0  | +73159- | 10 | 0 | +31620- | 10    | 9R+  | 0+      | 0  |
| 0    | +17147- | 3  | 0 | -10966- | 3     | 0   | -59730- | 4     | 0  | +48172- | 5  | 0 | +72874- | 5     | 0    | +35133- | 5  |
| 0    | +14064- | 5  | 0 | +52833- | 6     | 0   | +19045- | 6     | 0  | +65487- | 7  | 0 | +20274- | 7     | 0    | +63416- | 8  |
| 0    | +25661- | 8  | 0 | +12448- | 8     | 0   | +56368- | 9     | 0  | +26708- | 9  | 0 | +12392- | 9     | 0    | +57670- | 10 |
| 0    | +25771- | 10 | 0 | +11139- | 10    | 8R+ | 0+      | 0     | 0  | +17147- | 3  | 0 | -85267- | 4     | 0    | -11475- | 3  |
| 0    | -12698- | 4  | 0 | +83893- | 5     | 0   | +52733- | 5     | 0  | +22518- | 5  | 0 | +86958- | 6     | 0    | +32269- | 6  |
| 0    | +11581- | 6  | 0 | +39757- | 7     | 0   | +12301- | 7     | 0  | +38469- | 8  | 0 | +15565- | 8     | 0    | +75504- | 9  |
| 0    | +34190- | 9  | 0 | +16199- | 9     | 0   | +75164- | 10    | 0  | +34978- | 10 | 0 | +15631- | 10    | 0    | +67559- | 11 |
| 7R+  | 0+      | 0  | 0 | +17147- | 3     | 0   | -85267- | 4     | 0  | -13668- | 3  | 0 | -41337- | 4     | 0    | +48171- | 5  |
| 0    | +72921- | 5  | 0 | +35218- | 5     | 0   | +14107- | 5     | 0  | +53355- | 6  | 0 | +19655- | 6     | 0    | +70351- | 7  |
| 0    | +24128- | 7  | 0 | +74625- | 8     | 0   | +23335- | 8     | 0  | +94412- | 9  | 0 | +45796- | 9     | 0    | +20737- | 9  |
| 0    | +98254- | 10 | 0 | +45589- | 10    | 0   | +21216- | 10    | 0  | +94806- | 11 | 0 | +40977- | 11    | 6R+  | 0+      | 0  |
| 0    | +17147- | 3  | 0 | -85267- | 4     | 0   | -13668- | 3     | 0  | -54228- | 4  | 0 | -44090- | 5     | 0    | +83893- | 5  |
| 0    | +52765- | 5  | 0 | +22572- | 5     | 0   | +87225- | 6     | 0  | +32587- | 6  | 0 | +11951- | 6     | 0    | +42709- | 7  |







|     |           |   |               |         |               |    |           |   |           |           |           |           |           |           |   |
|-----|-----------|---|---------------|---------|---------------|----|-----------|---|-----------|-----------|-----------|-----------|-----------|-----------|---|
| 0   | +61179-10 | 0 | +20874-1012R+ | 0+      | 0             | 0  | +32043-   | 4 | 0         | -16200-   | 3         | 0         | +75450-   | 4         |   |
| 0   | +39448-   | 4 | 0             | +10967- | 4             | 0  | +25600-   | 5 | 0         | +54734-   | 6         | 0         | +10358-   | 7         |   |
| 0   | +59802-   | 8 | 0             | +22775- | 8             | 0  | +79535-   | 9 | 0         | +29530-   | 9         | 0         | +10683-   | 10        |   |
| 0   | +13652-10 | 0 | +46581-1111R+ | 0+      | 0             | 0  | +32043-   | 4 | 0         | -16204-   | 3         | 0         | +75639-   | 4         |   |
| 0   | +39568-   | 4 | 0             | +11072- | 4             | 0  | +26441-   | 5 | 0         | +58720-   | 6         | 0         | +12337-   | 7         |   |
| 0   | +45866-   | 8 | 0             | +13353- | 8             | 0  | +50841-   | 9 | 0         | +17751-   | 9         | 0         | +65902-10 | 0         |   |
| 0   | +87053-11 | 0 | +30464-11     | 0       | +10394-1110R+ | 0+ | 0         | 0 | +78653-   | 4         | 0         | -16311-   | 3         |           |   |
| 0   | +57830-   | 4 | 0             | +33641- | 4             | 0  | +95793-   | 5 | 0         | +23141-   | 5         | 0         | +52674-   | 6         |   |
| 0   | +24014-   | 7 | 0             | +45055- | 8             | 0  | +89012-   | 9 | 0         | +25909-   | 9         | 0         | +98633-10 | 0         |   |
| 0   | +12784-10 | 0 | +46242-11     | 0       | +16886-11     | 0  | +59093-12 | 0 | +20162-12 | 9R+       | 0+        | 0         | +34436-10 | 0         |   |
| 0   | +12621-   | 3 | 0             | -16823- | 3             | 0  | +17095-   | 4 | 0         | +32232-   | 4         | 0         | +10359-   | 4         |   |
| 0   | +60049-   | 6 | 0             | +13472- | 6             | 0  | +29260-   | 7 | 0         | +60979-   | 8         | 0         | +11433-   | 8         |   |
| 0   | +65720-10 | 0 | +25019-10     | 0       | +87347-11     | 0  | +32426-11 | 0 | +11729-11 | 0         | +18833-   | 3         | 0         | -49242-   | 4 |
| 0   | +14989-12 | 0 | +51138-13     | 8R+     | 0+            | 0  | +12621-   | 3 | 0         | -18833-   | 3         | 0         | +63851-   | 7         |   |
| 0   | +41799-   | 4 | 0             | +19294- | 4             | 0  | +52665-   | 5 | 0         | +12556-   | 5         | 0         | +28628-   | 6         |   |
| 0   | +13839-   | 7 | 0             | +28818- | 8             | 0  | +54013-   | 9 | 0         | +10667-   | 9         | 0         | +31045-   | 10        |   |
| 0   | +41261-11 | 0 | +15317-11     | 0       | +55405-12     | 0  | +20232-12 | 0 | +70800-13 | 0         | +24156-13 | 0         | +32232-   | 4         |   |
| 7R+ | 0+        | 0 | 0             | +12621- | 3             | 0  | -18833-   | 3 | 0         | -82533-   | 4         | 0         | +35136-   | 4         |   |
| 0   | +10365-   | 4 | 0             | +25972- | 5             | 0  | +60227-   | 6 | 0         | +13599-   | 6         | 0         | +30223-   | 7         |   |
| 0   | +13616-   | 8 | 0             | +25517- | 9             | 0  | +50390-10 | 0 | +14665-10 | 0         | +55827-11 | 0         | +19490-11 | 0         |   |
| 0   | +72352-12 | 0 | +26171-12     | 0       | +95569-13     | 0  | +33444-13 | 0 | +11411-13 | 6R+       | 0+        | 0         | 0         | 0         |   |
| 0   | +12621-   | 3 | 0             | -18833- | 3             | 0  | -82533-   | 4 | 0         | +29310-   | 4         | 0         | +41971-   | 4         |   |
| 0   | +52692-   | 5 | 0             | +12587- | 5             | 0  | +28714-   | 6 | 0         | +64453-   | 7         | 0         | +14294-   | 7         |   |
| 0   | +64330-   | 9 | 0             | +12054- | 9             | 0  | +23803-10 | 0 | +69274-11 | 0         | +26371-11 | 0         | +92066-12 | 0         |   |
| 0   | +34177-12 | 0 | +12363-12     | 0       | +45144-13     | 0  | +15798-13 | 0 | +53901-14 | 5R+       | 0+        | 0         | 0         | 0         |   |
| 0   | +12621-   | 3 | 0             | -18833- | 3             | 0  | -82533-   | 4 | 0         | +29310-   | 4         | 0         | +44961-   | 4         |   |
| 0   | +10365-   | 4 | 0             | +25985- | 5             | 0  | +60374-   | 6 | 0         | +13639-   | 6         | 0         | +30508-   | 7         |   |
| 0   | +14607-   | 8 | 0             | +30390- | 9             | 0  | +56941-10 | 0 | +11244-10 | 0         | +32723-11 | 0         | +12457-11 | 0         |   |
| 0   | +43489-12 | 0 | +16144-12     | 0       | +58397-13     | 0  | +21324-13 | 0 | +74623-14 | 0         | +25460-14 | 0         | +70384-   | 4         |   |
| 5R+ | 0+        | 0 | 0             | -12620- | 3             | 0  | +62122-   | 4 | 0         | +14465-   | 3         | 0         | +11534-   | 3         |   |
| 0   | +33116-   | 4 | 0             | +10279- | 4             | 0  | +24111-   | 5 | 0         | +54754-   | 6         | 0         | +12268-   | 6         |   |
| 0   | +60532-   | 8 | 0             | +13080- | 8             | 0  | +27209-   | 9 | 0         | +50978-10 | 0         | +10066-10 | 0         | +29295-11 | 0 |
| 0   | +11152-11 | 0 | +38934-12     | 0       | +14453-12     | 0  | +52280-13 | 0 | +19091-13 | 0         | +66806-14 | 0         | 0         | 0         |   |
| 0   | +22793-14 | 0 | 0             | 0       | 0             | 0  | 0         | 0 | 0         | 0         | 0         | 0         | 0         | 0         |   |
| 0   | +96740-   | 6 | 0             | 0       | 0             | 0  | +11375-   | 4 | 0         | +64633-   | 524R+     | 0+        | 0         | +48740-   | 6 |
| 0   | 0         | 0 | 0             | 0       | 0             | 0  | +12591-   | 4 | 0         | +30378-   | 523R+     | 0+        | 0         | +78984-   | 8 |
| 0   | 0         | 0 | 0             | 0       | 0             | 0  | 0         | 0 | 0         | 0         | 0         | 0         | 0         | 0         | 0 |

26

27

28

29

30

31

32

33

34

35

36

37

38

39

40

41

42

43

44

45

46

47

48

49

50

51

52

53

54

55

56

57

58

59

1

2

|     |   |        |       |     |   |        |        |        |        |        |        |        |        |   |        |        |        |       |        |        |   |   |   |
|-----|---|--------|-------|-----|---|--------|--------|--------|--------|--------|--------|--------|--------|---|--------|--------|--------|-------|--------|--------|---|---|---|
| 0   | + | 0      | +     | 0   | 0 | +      | 15485- | 4      | 0      | +      | 13530- | 4      | 0      | + | 46354- | 5      | 0      | +     | 20971- | 622R+  | 0 | + | 0 |
| 0   | + | 21485- | 12    | 0   | + | 0      | +      | 19873- | 4      | 0      | +      | 14921- | 4      | 0 | +      | 19473- | 5      | 0     | +      | 0      | + | 0 | 0 |
| 0   | + | 29165- | 621R+ | 0   | + | 0      | +      | 27538- | 12     | 0      | +      | 0      | +      | 0 | +      | 41118- | 4      | 0     | +      | 30948- | 4 | 0 | 0 |
| 0   | + | 49514- | 5     | 2R+ | 0 | +      | 0      | +      | 20968- | 620R+  | 0      | +      | 0      | + | 0      | +      | 35164- | 12    | 0      | +      | 0 | + | 0 |
| 0   | + | 31383- | 4     | 0   | + | 25960- | 0      | +      | 10169- | 4      | 3R+    | 0      | +      | 0 | +      | 10409- | 619R+  | 0     | +      | 0      | + | 0 |   |
| 0   | + | 45629- | 12    | 0   | + | 0      | +      | 67243- | 4      | 0      | +      | 55144- | 4      | 0 | +      | 54239- | 5      | 4R+   | 0      | +      | 0 | 0 |   |
| 0   | + | 56017- | 718R+ | 0   | + | 0      | +      | 58159- | 12     | 0      | +      | 0      | +      | 0 | +      | 35459- | 4      | 0     | +      | 26914- | 4 | 0 |   |
| 0   | + | 12100- | 4     | 5R+ | 0 | +      | 0      | +      | 27308- | 717R+  | 0      | +      | 0      | + | 0      | +      | 79409- | 12    | 0      | +      | 0 | 0 |   |
| 0   | + | 35710- | 4     | 0   | + | 30233- | 4      | 0      | +      | 85452- | 5      | 6R+    | 0      | + | 0      | +      | 50930- | 816R+ | 0      | +      | 0 | 0 |   |
| 0   | + | 12357- | 11    | 0   | + | 0      | +      | 36417- | 4      | 0      | +      | 32306- | 4      | 0 | +      | 54770- | 5      | 7R+   | 0      | +      | 0 | 0 |   |
| 0   | + | 24233- | 815R+ | 0   | + | 0      | +      | 20522- | 11     | 0      | +      | 0      | +      | 0 | +      | 36807- | 4      | 0     | +      | 32459- | 4 | 0 |   |
| 0   | + | 41106- | 5     | 8R+ | 0 | +      | 0      | +      | 18796- | 914R+  | 0      | +      | 0      | + | 0      | +      | 33874- | 11    | 0      | +      | 0 | 0 |   |
| 0   | + | 36951- | 4     | 0   | + | 32567- | 4      | 0      | +      | 43483- | 523R+  | 0      | +      | 0 | +      | 55966- | 11     | 0     | +      | 0      | + | 0 |   |
| 0   | + | 37009- | 4     | 0   | + | 32526- | 4      | 0      | +      | 43840- | 523R+  | 0      | +      | 0 | +      | 92272- | 11     | 0     | +      | 0      | + | 0 |   |
| 0   | + | 37030- | 4     | 0   | + | 32547- | 4      | 0      | +      | 44826- | 523R+  | 0      | +      | 0 | +      | 15213- | 10     | 0     | +      | 0      | + | 0 |   |
| 0   | + | 37037- | 4     | 0   | + | 32555- | 4      | 0      | +      | 44821- | 523R+  | 0      | +      | 0 | +      | 25083- | 10     | 0     | +      | 0      | + | 0 |   |
| 0   | + | 37040- | 4     | 0   | + | 32558- | 4      | 0      | +      | 44818- | 523R+  | 0      | +      | 0 | +      | 41355- | 10     | 0     | +      | 0      | + | 0 |   |
| 0   | + | 37040- | 4     | 0   | + | 32559- | 4      | 0      | +      | 44818- | 523R+  | 0      | +      | 0 | +      | 68183- | 10     | 0     | +      | 0      | + | 0 |   |
| 0   | + | 37040- | 4     | 0   | + | 32558- | 4      | 0      | +      | 44818- | 523R+  | 0      | +      | 0 | +      | 10513- | 9      | 0     | +      | 0      | + | 0 |   |
| 0   | + | 37040- | 4     | 0   | + | 31064- | 4      | 0      | +      | 44816- | 523R+  | 0      | +      | 0 | +      | 14322- | 9      | 0     | +      | 0      | + | 0 |   |
| 0   | + | 37040- | 4     | 0   | + | 28076- | 4      | 0      | +      | 59755- | 523R+  | 0      | +      | 0 | +      | 18390- | 9      | 0     | +      | 0      | + | 0 |   |
| 0   | + | 37040- | 4     | 0   | + | 28076- | 4      | 0      | +      | 89632- | 523R+  | 0      | +      | 0 | +      | 23614- | 9      | 0     | +      | 0      | + | 0 |   |
| 0   | + | 37040- | 4     | 0   | + | 28076- | 4      | 0      | +      | 89632- | 523R+  | 0      | +      | 0 | +      | 30321- | 9      | 0     | +      | 0      | + | 0 |   |
| 0   | + | 37040- | 4     | 0   | + | 28077- | 4      | 0      | +      | 89637- | 523R+  | 0      | +      | 0 | +      | 38933- | 9      | 0     | +      | 0      | + | 0 |   |
| 0   | + | 37040- | 4     | 0   | + | 28079- | 4      | 0      | +      | 89637- | 523R+  | 0      | +      | 0 | +      | 16000- | 8      | 0     | +      | 0      | + | 0 |   |
| 0   | + | 37042- | 4     | 0   | + | 37040- | 4      | 0      | +      | 89619- | 523R+  | 0      | +      | 0 | +      | 0      | 0      | 0     | 0      | 0      | 0 | 0 |   |
| 3R+ | 0 | +      | 0     | 0   | + | 78878- | 527R+  | 0      | +      | 0      | 0      | +      | 17432- | 4 | 0      | +      | 28662- | 526R+ | 0      | +      | 0 | 0 |   |
| 0   | + | 10125- | 4     | 0   | + | 16815- | 526R+  | 0      | +      | 0      | 0      | +      | 11739- | 4 | 0      | +      | 19975- | 526R+ | 0      | +      | 0 | 0 |   |
| 0   | + | 23614- | 4     | 0   | + | 37826- | 526R+  | 0      | +      | 0      | 0      | +      | 25060- | 4 | 0      | +      | 13301- | 426R+ | 0      | +      | 0 | 0 |   |
| 0   | + | 34147- | 4     | 0   | + | 94703- | 626R+  | 0      | +      | 0      | 0      | +      | 85418- | 6 | 0      | +      | 16342- | 426R+ | 0      | +      | 0 | 0 |   |
| 0   | + | 43925- | 5     | 0   | + | 93933- | 526R+  | 0      | +      | 0      | 0      | +      | 61150- | 5 | 0      | +      | 54018- | 526R+ | 0      | +      | 0 | 0 |   |
| 0   | + | 77900- | 5     | 0   | + | 38708- | 526R+  | 0      | +      | 0      | 0      | +      | 83548- | 5 | 0      | +      | 40215- | 526R+ | 0      | +      | 0 | 0 |   |
| 0   | + | 86422- | 5     | 0   | + | 40273- | 526R+  | 0      | +      | 0      | 0      | +      | 87142- | 5 | 0      | +      | 41073- | 526R+ | 0      | +      | 0 | 0 |   |
| 0   | + | 87402- | 5     | 0   | + | 41030- | 526R+  | 0      | +      | 0      | 0      | +      | 87500- | 5 | 0      | +      | 41015- | 526R+ | 0      | +      | 0 | 0 |   |
| 0   | + | 87532- | 5     | 0   | + | 41010- | 526R+  | 0      | +      | 0      | 0      | +      | 87544- | 5 | 0      | +      | 41005- | 526R+ | 0      | +      | 0 | 0 |   |
| 0   | + | 10121- | 4     | 0   | + | 41005- | 526R+  | 0      | +      | 0      | 0      | +      | 12855- | 4 | 0      | +      | 54674- | 526R+ | 0      | +      | 0 | 0 |   |

|     |         |       |   |         |       |    |   |   |         |   |   |         |       |    |   |    |
|-----|---------|-------|---|---------|-------|----|---|---|---------|---|---|---------|-------|----|---|----|
| 0   | +12855- | 4     | 0 | -82011- | 526R+ | 0+ | 0 | 0 | +12855- | 4 | 0 | -82011- | 526R+ | 0+ | 0 | 11 |
| 0   | +12852- | 4     | 0 | -82006- | 526R+ | 0+ | 0 | 0 | +12852- | 4 | 0 | -82021- | 527R+ | 0+ | 0 | 12 |
| 0   | -81926- | 523R+ | 0 | 0       | 0     | 0+ | 0 | 0 | 0       | 0 | 0 | 0       | 0     | 0+ | 0 | 13 |
| 3R+ | 0+      | 0     | 0 | +79223- | 527R+ | 0+ | 0 | 0 | +18138- | 4 | 0 | -24104- | 726R+ | 0+ | 0 | 1  |
| 0   | +12180- | 4     | 0 | -74940- | 726R+ | 0+ | 0 | 0 | +10650- | 4 | 0 | +30366- | 626R+ | 0+ | 0 | 2  |
| 0   | +39459- | 4     | 0 | +13209- | 526R+ | 0+ | 0 | 0 | +62603- | 5 | 0 | +75452- | 526R+ | 0+ | 0 | 3  |
| 0   | +30878- | 4     | 0 | -31364- | 526R+ | 0+ | 0 | 0 | -17116- | 5 | 0 | +49266- | 526R+ | 0+ | 0 | 4  |
| 0   | -32360- | 6     | 0 | +85256- | 626R+ | 0+ | 0 | 0 | +17170- | 6 | 0 | -82845- | 726R+ | 0+ | 0 | 5  |
| 0   | +40293- | 6     | 0 | -23385- | 626R+ | 0+ | 0 | 0 | +48592- | 6 | 0 | -31635- | 626R+ | 0+ | 0 | 6  |
| 0   | +52372- | 6     | 0 | -34488- | 626R+ | 0+ | 0 | 0 | +53464- | 6 | 0 | -36243- | 626R+ | 0+ | 0 | 7  |
| 0   | +53866- | 6     | 0 | -36601- | 626R+ | 0+ | 0 | 0 | +54011- | 6 | 0 | -36731- | 626R+ | 0+ | 0 | 8  |
| 0   | +54064- | 6     | 0 | -36779- | 626R+ | 0+ | 0 | 0 | +54086- | 6 | 0 | -36796- | 626R+ | 0+ | 0 | 9  |
| 0   | +66366- | 6     | 0 | -36801- | 626R+ | 0+ | 0 | 0 | +90905- | 6 | 0 | -49072- | 626R+ | 0+ | 0 | 10 |
| 0   | +90900- | 6     | 0 | -73613- | 626R+ | 0+ | 0 | 0 | +90910- | 6 | 0 | -73613- | 626R+ | 0+ | 0 | 11 |
| 0   | +90635- | 6     | 0 | -73614- | 626R+ | 0+ | 0 | 0 | +90660- | 6 | 0 | -73399- | 627R+ | 0+ | 0 | 12 |
| 0   | -74970- | 623R+ | 0 | 0       | 0     | 0+ | 0 | 0 | 0       | 0 | 0 | 0       | 0     | 0+ | 0 | 13 |
| 3R+ | 0+      | 0     | 0 | +10524- | 427R+ | 0+ | 0 | 0 | +16198- | 4 | 0 | +10183- | 526R+ | 0+ | 0 | 1  |
| 0   | +63712- | 5     | 0 | +39721- | 626R+ | 0+ | 0 | 0 | +58970- | 5 | 0 | +15029- | 626R+ | 0+ | 0 | 2  |
| 0   | +11450- | 4     | 0 | -36167- | 626R+ | 0+ | 0 | 0 | -62607- | 6 | 0 | -70290- | 526R+ | 0+ | 0 | 3  |
| 0   | +62603- | 5     | 0 | -25216- | 526R+ | 0+ | 0 | 0 | +14194- | 6 | 0 | -65890- | 626R+ | 0+ | 0 | 4  |
| 0   | -18755- | 7     | 0 | +15191- | 726R+ | 0+ | 0 | 0 | -33061- | 7 | 0 | -34957- | 826R+ | 0+ | 0 | 5  |
| 0   | -24239- | 7     | 0 | -11734- | 726R+ | 0+ | 0 | 0 | -21058- | 7 | 0 | -16045- | 726R+ | 0+ | 0 | 6  |
| 0   | -19596- | 7     | 0 | -17575- | 726R+ | 0+ | 0 | 0 | -19193- | 7 | 0 | -18428- | 726R+ | 0+ | 0 | 7  |
| 0   | -19028- | 7     | 0 | -18613- | 726R+ | 0+ | 0 | 0 | -18981- | 7 | 0 | -18690- | 726R+ | 0+ | 0 | 8  |
| 0   | -18952- | 7     | 0 | -18709- | 726R+ | 0+ | 0 | 0 | -18939- | 7 | 0 | -18725- | 726R+ | 0+ | 0 | 9  |
| 0   | -12694- | 7     | 0 | -18728- | 726R+ | 0+ | 0 | 0 | -20501- | 9 | 0 | -24972- | 726R+ | 0+ | 0 | 10 |
| 0   | -20501- | 9     | 0 | -37459- | 726R+ | 0+ | 0 | 0 | -23750- | 9 | 0 | -37460- | 726R+ | 0+ | 0 | 11 |
| 0   | -84985- | 8     | 0 | -37262- | 726R+ | 0+ | 0 | 0 | -88870- | 8 | 0 | -40214- | 727R+ | 0+ | 0 | 12 |
| 0   | -19009- | 723R+ | 0 | 0       | 0     | 0+ | 0 | 0 | 0       | 0 | 0 | 0       | 0     | 0+ | 0 | 13 |
| 3R+ | 0+      | 0     | 0 | +11561- | 427R+ | 0+ | 0 | 0 | +84935- | 5 | 0 | +87655- | 626R+ | 0+ | 0 | 1  |
| 0   | +82679- | 6     | 0 | -17707- | 526R+ | 0+ | 0 | 0 | +33709- | 5 | 0 | +80527- | 726R+ | 0+ | 0 | 2  |
| 0   | -21724- | 5     | 0 | -10479- | 526R+ | 0+ | 0 | 0 | -20051- | 6 | 0 | +25015- | 526R+ | 0+ | 0 | 3  |
| 0   | +43074- | 6     | 0 | -49868- | 626R+ | 0+ | 0 | 0 | +33986- | 7 | 0 | -16068- | 726R+ | 0+ | 0 | 4  |
| 0   | +68192- | 9     | 0 | -24914- | 826R+ | 0+ | 0 | 0 | +35900- | 7 | 0 | +15228- | 726R+ | 0+ | 0 | 5  |
| 0   | +33949- | 7     | 0 | +11107- | 726R+ | 0+ | 0 | 0 | +33263- | 7 | 0 | +11506- | 726R+ | 0+ | 0 | 6  |
| 0   | +32931- | 7     | 0 | +11567- | 726R+ | 0+ | 0 | 0 | +32886- | 7 | 0 | +11724- | 726R+ | 0+ | 0 | 7  |

|     |         |       |         |       |        |         |     |         |       |      |
|-----|---------|-------|---------|-------|--------|---------|-----|---------|-------|------|
| 0   | +32821- | 7 0   | +11709- | 726R+ | 0+ 0 0 | +32822- | 7 0 | +11718- | 726R+ | 0+ 0 |
| 0   | +32808- | 7 0   | +11706- | 726R+ | 0+ 0 0 | +32856- | 7 0 | +11717- | 726R+ | 0+ 0 |
| 0   | +28949- | 7 0   | +11717- | 726R+ | 0+ 0 0 | +21139- | 7 0 | +15623- | 726R+ | 0+ 0 |
| 0   | +21137- | 7 0   | +23434- | 726R+ | 0+ 0 0 | +21123- | 7 0 | +23434- | 726R+ | 0+ 0 |
| 0   | +17272- | 7 0   | +23347- | 726R+ | 0+ 0 0 | +17656- | 7 0 | +27327- | 727R+ | 0+ 0 |
| 0   | +28150- | 923R+ | 0+      | 0     | 0+ 0 0 | +14453- | 5 0 | -14976- | 526R+ | 0+ 0 |
| 3R+ | 0+      | 0 0   | +49683- | 527R+ | 0+ 0 0 | +82715- | 6 0 | -42183- | 626R+ | 0+ 0 |
| 0   | -10810- | 6 0   | -12182- | 526R+ | 0+ 0 0 | +10842- | 6 0 | +61572- | 626R+ | 0+ 0 |
| 0   | -66131- | 6 0   | -66291- | 626R+ | 0+ 0 0 | +24903- | 7 0 | -39211- | 726R+ | 0+ 0 |
| 0   | +38037- | 7 0   | -18498- | 626R+ | 0+ 0 0 | -47683- | 7 0 | -15523- | 726R+ | 0+ 0 |
| 0   | -65863- | 8 0   | -30478- | 726R+ | 0+ 0 0 | -45128- | 7 0 | -11304- | 726R+ | 0+ 0 |
| 0   | -45799- | 7 0   | -11078- | 726R+ | 0+ 0 0 | -44778- | 7 0 | -11424- | 726R+ | 0+ 0 |
| 0   | -44853- | 7 0   | -11307- | 726R+ | 0+ 0 0 | -44739- | 7 0 | -11407- | 726R+ | 0+ 0 |
| 0   | -44731- | 7 0   | -11395- | 726R+ | 0+ 0 0 | -44750- | 7 0 | -11404- | 726R+ | 0+ 0 |
| 0   | -44718- | 7 0   | -11387- | 726R+ | 0+ 0 0 | -33347- | 7 0 | -15205- | 726R+ | 0+ 0 |
| 0   | -40948- | 7 0   | -11404- | 726R+ | 0+ 0 0 | -33398- | 7 0 | -22807- | 726R+ | 0+ 0 |
| 0   | -33346- | 7 0   | -22807- | 726R+ | 0+ 0 0 | -46434- | 7 0 | -27554- | 727R+ | 0+ 0 |
| 0   | -45616- | 7 0   | -22782- | 726R+ | 0+ 0 0 |         |     |         |       |      |
| 0   | +52350- | 823R+ | 0+      | 0     |        |         |     |         |       |      |

|        |   |                    |                    |              |
|--------|---|--------------------|--------------------|--------------|
| 17*    | T | -1046934322120R0.0 | -0914776909920R0.0 | -09229049797 |
| 20R0.0 |   | -0921922349820R0.0 | -0915731879920R0.0 | -10952516988 |
| 20R0.0 |   | -1052174839220R0.0 | -1026933229720R0.0 | -10172814498 |
| 20R0.0 |   | -1167309979320R0.0 | -11133226937 F0.0  | T            |
| 3*     |   | F0.0               |                    |              |
| 1*     |   | F0.0               |                    |              |
| 4*     |   | 0.0                |                    |              |
| 5*     |   | F0.0               |                    |              |
| 6*     |   | 0.0                |                    |              |
|        |   | 1910.5             | 20.5               |              |
|        |   | .0244936           | .0413296           | .0392569     |
|        |   | .0643754           | .1371702           | .1090850     |
|        |   | .0442097           | .0392569           | .0244936     |
|        |   | -.9902984          | -.9092855          | -.7467506    |
|        |   | -.6504264          | -.1389568          | .3922893     |
|        |   | .5370966           | .8319966           | .9805009     |
|        |   |                    |                    |              |
| 8\$    |   | 120R               |                    |              |
| 9\$    |   | 1                  |                    |              |
|        |   | 19                 |                    |              |

19

24 41

19

24 41

19

41

10\$

24

11\$

6R 0.0

12\*

2R

19\$

0101

7

18

6R.0667

6R.0333

5 T

T

```

//SABINE JOB (260,7011,15,5),50853 ROBERT*
// EXEC FORTHCLG,PARM,FORT=BCD,NOTERM*,
// PARM,LKED=XREF,LET,LIST,OVLY,REGION,GO=260K,TIME=15
//FORT.SYSRINT DD DUMMY,SYSOUT=
//FORT.SYSLIN DD SPACE=(800,(500,50),RLSE)
//FORT.SYSIN DD UNIT=TAPE,DSN=SABINE,LABEL=(2,SL),DISP=OLD,
// VOL=SER=T1927,DCB=(RECFM=FB,LRECL=80,BLKSIZE=3200)
//LKED.SYSIN DD *
OVERLAY A STEU1,MAINNS,RMACRO,MACRO,PREPRO,MAINNF,SNCS,SNOSP,NHFSP, X
INSERT STEU1,MAINNS,RMACRO,MACRO,PREPRO,MAINNF,SNCS,SNOSP,NHFSP, X
OVERLAY A STEU2,SSSP,SCSP,GMACRO,SGOSP,MAINS,BINT,BUP,MFCTSP, X
INSERT CYPHE,G2FSP,G1FSP,MAING,CYPLAN,WGAM X
OVERLAY A NEUTRO,LIBE,ELENA,STAMPA,ESSE,ENNE,MEDIA,AIRGAP,FDERN,COEFB, X
INSERT DOSE
//GO.FT02F001 DD UNIT=SYSDA,SPACE=(TRK,(20,5)),
// DCB=(RECFM=VB,LRECL=3516,BLKSIZE=3520)
//GO.FT03F001 DD UNIT=SYSDA,SPACE=(TRK,(20,5)),
// DCB=(RECFM=VB,LRECL=3516,BLKSIZE=3520)
//GO.FT04F001 DD UNIT=SYSDA,SPACE=(TRK,(20,5)),
// DCB=(RECFM=VB,LRECL=3516,BLKSIZE=3520)
//GO.FT09F001 DD UNIT=TAPE,DSN=SABINE,LIBRARY,LABEL=(1,SL),
// VOL=(PRIVATE,RETAIN,SER=T1929),DISP=OLD,DCB=(RECFM=V,LRECL=3600)
//GO.FT10F001 DD UNIT=SYSDA,SPACE=(TRK,(20,5)),
// DCB=(RECFM=VB,LRECL=3516,BLKSIZE=3520)
//GO.SYSIN DD *

```

INFINITE HOMOGENOUS WATER PROBLEM, CF-252 SOURCE, 1.0 N/SEC

|       | 0   | 0    | 0   | 1   | 3   | 4     |     |       |     |      |     |       |     |
|-------|-----|------|-----|-----|-----|-------|-----|-------|-----|------|-----|-------|-----|
| 5.085 | -05 | 7.91 | -05 | 1.1 | -04 | 2.3   | -04 | 4.6   | -04 | 9.08 | -04 | 2.0   | -03 |
| 3.0   | -03 | 6.0  | -03 | 1.2 | -02 | 2.057 | -02 | 3.267 | -02 | 4.8  | -02 | 6.552 | -02 |
| 8.84  | -02 | 1.4  | -01 | 2.2 | -01 | 1.57  | -01 | 2.03  | -01 |      |     |       |     |



18-20  
18-21  
18-22  
18-23  
  
18-25  
18-26

3.4216 -04  
3.2632 -04  
3.1159 -04  
2.9780 -04  
2.8486 -04  
2.4527 -03  
2.2076 -02

-1.0  
-1.0  
-1.0  
-1.0  
-1.0  
-1.0  
-1.0

.0  
.0  
.0  
.0  
.0  
.0  
.0

.0  
.0  
.0  
.0  
.0  
.0  
.0

1  
1

1  
1

1  
1

1  
1

0  
0

1.0  
1.0

1.0  
1.0

E KIONZ-1A

PHOTOGRAPHED BY J. J. ...



## APPENDIX B

## FOIL ACTIVATION CORRECTION FACTORS

## 1. Thermal Flux Depression Correction

$$F(\text{th}) = 1 + \alpha/2 * (3RL/2\lambda(R+L) - 1) \quad \text{for } R \gg \lambda$$

$$F(\text{th}) = 1 + 0.34\alpha R/\lambda \quad \text{for } R \ll \lambda$$

where

$F(\text{th})$  = thermal neutron flux depression correction factor

$R$  = radius of foil

$L$  = diffusion length in medium

$\lambda$  = transport free mean path in medium

$\alpha$  = function of  $\Sigma_a d$

$d$  = average thickness of foil

$\Sigma_a$  = macroscopic absorption cross section for foil

Example: Indium foil activation in water medium.

$$R = 3.175 \text{ cm.}$$

$$L = 2.76 \text{ cm.}$$

$$\lambda = 0.51 \text{ cm.}$$

$$\Sigma_a d = t A \sigma_a / W$$

$$t = 0.0195 \text{ g/cm.}^2$$

$$A = 0.6023 \times 10^{24}$$

$$\sigma_a = 175 \text{ b for indium}(0.032 \text{ eV})$$

$$W = \text{atomic weight, for indium} = 115$$

$$\Sigma_a d = 0.0179$$

$$\alpha = 0.0358 \text{ (Taken from Fig. 10-12 of Price } \underline{(15)})$$

$$F(\text{th}) = 1.0598$$

## 2. Self-shielding Factor for Thermal Neutrons

$$K(\text{th})^* = P t \sigma / 1 - \exp(-Pt\sigma)$$

$P$  = atom density of target nuclei

$t$  = foil thickness

$\sigma$  = average thermal cross section

Example: for indium foils

$$P = 0.037 \times 10^{24} \text{ atom/cc.}$$

$$t = 2.68 \times 10^{-3} \text{ cm.}$$

$$\sigma \approx 130 \text{ barns}$$

$$K(\text{th})^* = 1.0056$$

## 3. Self-shielding Factor for Resonance Neutrons

$$K(\text{r})^* = P t \sigma_r / 1 - \exp(-Pt\sigma_r)$$

Example: for indium foils

$$\sigma_r \approx 2640 \text{ barns}$$

$$K(\text{r})^* = 1.135$$

\* Assuming neutron beam direction is normal to the plane of the foil.

## VITA

James Thomas Robert was born in Lutcher, Louisiana on January 26, 1950. He was raised in nearby Gramercy, Louisiana and attended Lutcher High School graduating in May, 1968. He entered Louisiana State University in September, 1968 and graduated in December, 1972 with a Bachelor of Science degree in Engineering Science. In June, 1973 he entered the Graduate School of Louisiana State University seeking a post-graduate degree in Nuclear Engineering. He is presently a candidate for the Master of Science degree in the Department of Nuclear Engineering.